

EDR-8010 Series Quick Installation Guide

Moxa Industrial Secure Router

Version 2.0, January 2024

Technical Support Contact Information
www.moxa.com/support

MOXA[®]

© 2024 Moxa Inc. All rights reserved.

P/N: 1802080100012



Package Checklist

The EDR-8010 Series secure router is shipped with the items listed below. If any of these items are missing or damaged, please contact your customer service representative for assistance.

- 1 Industrial secure router
- 1 USB-C-to-DB9 cable
- Quick installation guide (printed)
- Protective caps for unused ports
- Warranty card

Features

Advanced Industrial Networking Capability

- Industrial-grade Intrusion Prevention/Detection System (IPS/IDS)
- All-in-one firewall/NAT/VPN/router/switch with 8 FE + 2 Gigabit ports
- Visualize OT security with the MXsecurity management software
- Secure remote access tunnel with VPN
- Examine industrial protocol data with Deep Packet Inspection (DPI) technology
- Easy network setup with Network Address Translation (NAT)
- RSTP/Turbo Ring redundant protocol enhances network redundancy
- Developed according to IEC 62443-4-2 with Secure Boot
- -40 to 75°C operating temperature range (-T model)

Panel Views of EDR-8010 Series

EDR-8010 Series

Front Panel

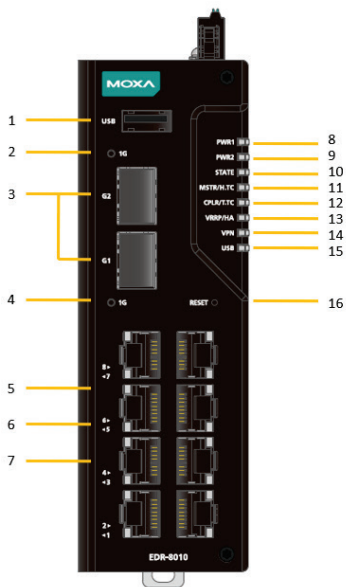

Front Panel:

1. USB port for ABC-02-USB
2. 1G SFP port speed LED indicator
3. 1G SFP ports
4. 1G SFP port speed LED indicator
5. 100 Mbps copper port speed LED indicator
6. 10 Mbps copper port speed LED indicator
7. 10/100 Mbps copper ports
8. Power input PWR1 LED indicator
9. Power input PWR2 LED indicator
10. STATE LED indicator
11. MSTR/H.TC LED indicator
12. CPLR/T.TC LED indicator
13. VRRP/HA LED indicator
14. VPN LED indicator
15. USB LED indicator
16. Reset button

Top Panel

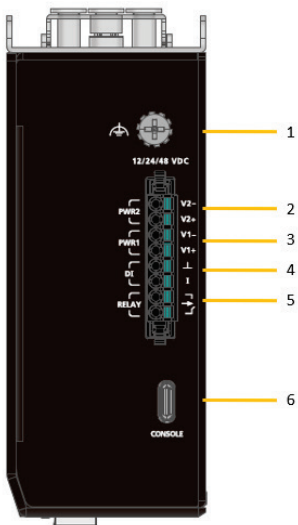

Top Panel:

1. Grounding screw
2. Terminal block with latch for Power 2 input
3. Terminal block with latch for Power 1 input
4. Terminal block with latch for digital input
5. Terminal block with latch for relay output
6. Type-C serial console port

Rear Panel

Rear Panel:

1. DIN-rail mounting kit

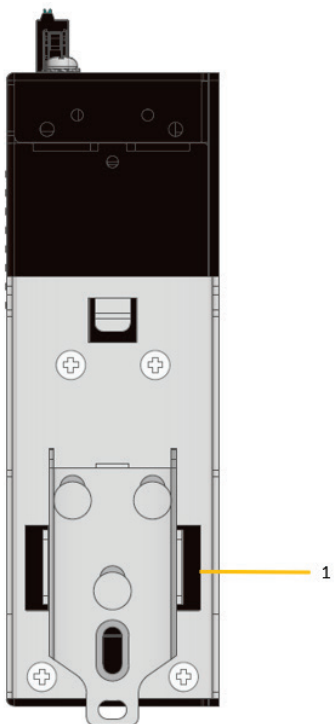

Mounting Dimensions

EDR-8010 Series

Unit: mm (inch)

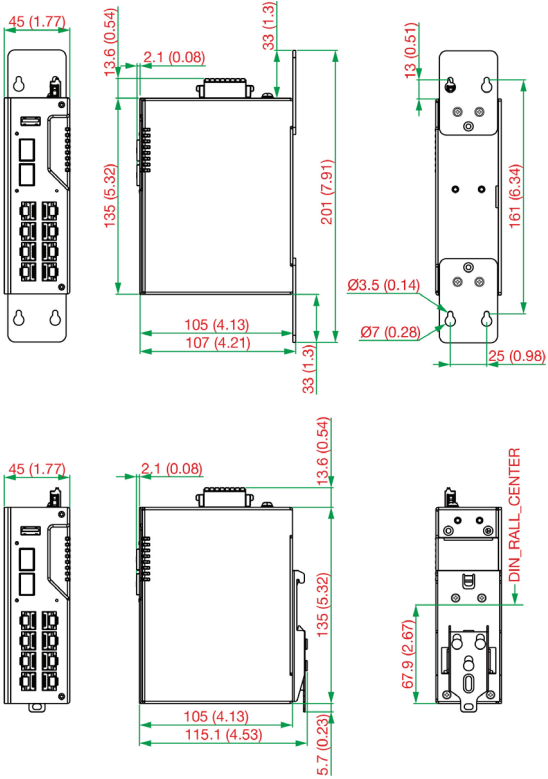

DIN-rail Mounting (DNV-certified)

In the package, the metal DIN-rail mounting kit is fixed to the back panel of the EDR-8010 Series with four screws (M3 x 6 mm). Mount the EDR-8010 Series on a corrosion-free mounting rail that adheres to the EN 60715 standard.

Suggested Installation Method

STEP 1:

Place the upper lip of the DIN-rail kit onto the mounting rail.

STEP 2:

Press the EDR-8010 Series towards the mounting rail until it snaps into place.

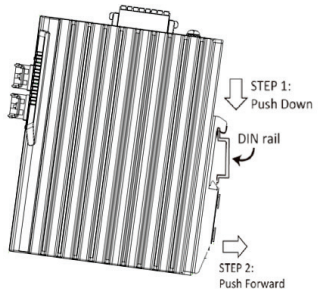

Suggested Removal Method

STEP 1:

Pull down the latch on the DIN-rail kit with a screwdriver.

STEPS 2 & 3:

Slightly pull the EDR-8010 Series forward and lift it up to remove it from the mounting rail.

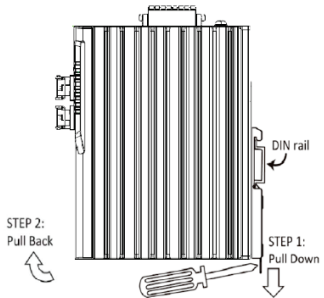

Wall Mounting

For some applications, you will find it convenient to mount the EDR-8010 Series on the wall, as shown in the following illustrations.

STEP 1: Remove the aluminum DIN-rail attachment plate from the rear panel of the EDR-8010 Series, and then attach both the wall-mounting plates with four screws (M3 x 5 mm).

Unit: mm (inch)

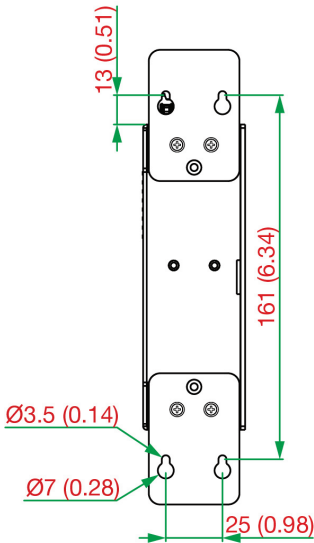

STEP 2: Mounting the EDR-8010 Series on the wall requires four screws. Use the EDR-8010 Series with the wall mount plates attached as a guide to mark the correct location of the four screws. The head of the screws should be less than 7.0 mm in diameter, and the shaft should be less than 3.5 mm in diameter.

Wiring Requirements



WARNING

Do not disconnect modules or wires unless power has been switched off or the area is known to be non-hazardous. The devices may only be connected to the supply voltage shown on the type plate. The devices are designed for operation with a Safety Extra-Low Voltage. Thus, they may only be connected to the supply voltage connections and to the signal contact with the Safety Extra-Low Voltages (SELV) in compliance with IEC 60950-1/VDE 0805.



ATTENTION

This unit is a built-in type. When the unit is installed in another piece of equipment, the equipment enclosing the unit must comply with fire enclosure regulation UL/IEC 62368-1 (or similar regulation).



ATTENTION

Safety First!

Be sure to disconnect the power cord before installing and/or wiring your EDR-8010 Series.

Calculate the maximum possible current in each power wire and common wire. Observe all electrical codes dictating the maximum current allowable for each wire size.

If the current goes above the maximum ratings, the wiring could overheat, causing serious damage to your equipment.

Please read and follow these guidelines:

- Use separate paths to route wiring for power and devices. If power wiring and device wiring paths must cross, make sure the wires are perpendicular at the intersection point.
NOTE: Do not run signal or communications wiring and power wiring through the same wire conduit. To avoid interference, wires with different signal characteristics should be routed separately.
- You can use the type of signal transmitted through a wire to determine which wires should be kept separate. The rule of thumb is that wiring sharing similar electrical characteristics can be bundled together.
- You should separate input wiring from output wiring.
- We advise that you label the wiring to all devices in the system.
- This product is intended for installation in Restricted Access Location.



WARNING

Hot Surface. Do not touch.



ATTENTION

The SFP module only supports Laser Class 1 optical transceivers.

Grounding the EDR-8010 Series

Grounding and wire routing help limit the effects of noise due to electromagnetic interference (EMI). Run the ground connection from the ground screw (M4 type) to the grounding surface prior to connecting devices.



ATTENTION

This product is intended to be mounted to a well-grounded mounting surface such as a metal panel. Use the green-and-yellow cable type AWG (American Wire Gauge) min. 16 (1.3 mm²) for grounding.

Wiring the Redundant Power Inputs

The EDR-8010 Series has two sets of power inputs—power input 1 and power input 2. The top and side views of the terminal block connector are shown below.

The input terminal block (TB1) should be installed using 16-24 AWG wires. The wiring for the input terminal block must be installed by a skilled person. The recommended wire stripping length is 8 to 9 mm.

Wire Type: Cu

The power cord adapter should be connected to a socket outlet with an earthing connection. The power cord and adapter must comply with Class I construction.

Instructions

This product is intended to be supplied by a UL Listed Power Adapter or DC power source marked 'L.P.S' or 'Limited Power Source', rated 12 to 48 VDC, 0.53 A (min.), and Tma 75°C (min.). If you require further assistance, please contact your Moxa representative.

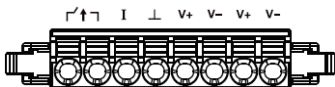

Top View

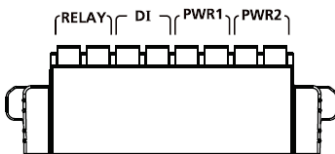

Right View

STEP 1:

Use a small flat-blade screwdriver to press a wire locker.

STEP 2:

Insert a positive/negative DC wire into the V+/V- terminals respectively.

STEP 3:

Release the wire locker and check whether the wire is fixed.

Communication Connections

Each EDR-8010 Series has three types of communication ports:

- 1 Type-C console port (RS-232 interface, baud rate: 115200, 8-N-1)
- 8 10/100BaseT(X) Ethernet ports
- 2 1G SFP ports

TYPE-C Console Port Connection

The EDR-8010 Series provides one Type-C console port located on the top panel. Connect the industrial secure router to a PC COM port using the Type-C-to-DB9 connection cable, and then launch a console terminal software, e.g. Moxa PComm Terminal Emulator, to access the EDR-8010 Series' console configuration utility.

TYPE-C-to-DB9 Cable Wiring

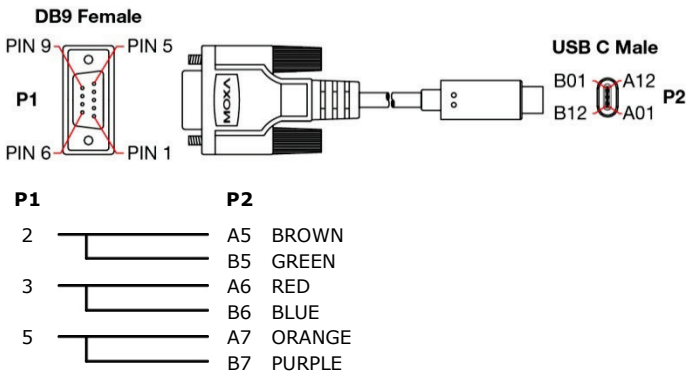

PIN Definition

Description	P1	P2
TXD	2	A5, B5
RXD	3	A6, B6
GND	5	A7, B7

10/100BaseT(X) Ethernet Port Connection

The 10/100BaseT(X) ports located on the EDR-8010 Series front panel are used to connect to Ethernet-enabled devices. Most users will choose to configure these ports for Auto MDI/MDI-X mode, in which case the port's pinouts are adjusted automatically depending on the type of Ethernet cable used (straight-through or cross-over), and the type of device (NIC-type or HUB/Switch-type) connected to the port. No matter which case you are connecting, we share pinouts for both MDI (NIC-type) ports and MDI-X (HUB/Switch-type) ports.

10/100Base T(x) RJ45 Pinouts

MDI Port Pinouts

Pin	Signal
1	Tx+
2	Tx-
3	Rx+
6	Rx-

MDI-X Port Pinouts

Pin	Signal
1	Rx+
2	Rx-
3	Tx+
6	Tx-

8-pin RJ45

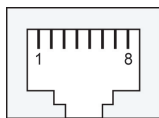

The Reset Button

Using a pointed object such as a straightened paperclip or toothpick, depress the Reset button for five seconds to load the factory default settings. When pressing down, the STATE LED will start to blink about once per second. Continue to depress until the STATE LED begins blinking more quickly, indicating that the device is resetting and you can release.

NOTE DO NOT power off the device when loading default settings.

LED Indicators

The front panel of the EDR-8010 Series has several LED indicators. The function of each LED is described in the following table:

LED	Color	State	Description
PWR1	Amber	On	Power is being supplied to power input P1 on the main module.
		Off	Power is NOT being supplied to power input P1 on the main module.
PWR2	Amber	On	Power is being supplied to power input P2 on the main module.
		Off	Power is NOT being supplied to power input P2 on the main module.
STATE	Green	On	The system passed the self-diagnosis test on boot-up and is ready to run.
		Blinking	Device reset is in progress, blinking once per second.
	Red	On	The system failed the self-diagnosis test on boot-up.
MSTR/ H.TC	Green	On	The EDR-8010 is set as the Master of the Turbo Ring, or as the Head of the Turbo Chain.
		Blinking	The Turbo Ring or the Turbo Chain is down.
		Off	The EDR-8010 is not set as the Master of this Turbo Ring or is set as a Member of the Turbo Chain.
CPLR/ T.TC	Green	On	The EDR-8010 Series' coupling function is enabled to form a backup path, or the device is set as the Tail of the Turbo Chain.
		Blinking	The Turbo Ring or the Turbo Chain is down.
		Off	The EDR-8010 Series' coupling function is disabled, or the device is set as a Member of the Turbo Chain.
VRRP/HA	Green	On	The EDR-8010 is set as the Master of the VRRP or HA.
		Off	The EDR-8010 is not set as the Master of the VRRP or HA.
VPN	Green	On	All VPN tunnels are working normally.
	Amber	On	Only parts of the VPN tunnels are working normally.
		Off	No active VPN connections.
USB	Green	On	USB drive successfully connected.
		Blinking	USB data is being transmitted.
	Red	On	USB dongle malfunction.
1G	Green	On	1G SFP link is up.
		Off	No link or the SFP link is down.
10/100 Mbps	Green	On	10 or 100 Mbps copper link is up.
		Off	No link or the copper link is down.

Specifications

Input Current	0.53 A @ 12 V 0.26 A @ 24 V 0.14 A @ 48 V
Input Voltage	12/24/48 VDC, dual power input DNV-certified for 24 VDC
Power Consumption	6.36 W (max.)
Operating Temperature	Standard models: -10 to 60°C (14 to 140°F) Wide-temp. models: -40 to 75°C (-40 to 167°F) DNV-certified for -25 to 70°C (-13 to 158°F)
Storage Temperature	-40 to 85°C (-40 to 185°F)
Compass Safety Distance	400 mm



SFP Module Guidelines

The ambient temperature range of standards models (without "-T" suffix) must be kept within 0 to 60 °C when the device is equipped with a standard temperature SFP module (without "-T" suffix) which model:

Refer to the list of Moxa Class I, 33 VDC SFP models below:

- SFP-1GSXLC(-T)
- SFP-1GLSXLC(-T)
- SFP-1G10ALC(-T)
- SFP-1G10BLC(-T)
- SFP-1GLXLC(-T)
- SFP-1G20ALC(-T)
- SFP-1G20BLC(-T)
- SFP-1GLHLC(-T)
- SFP-1G40ALC(-T)
- SFP-1G40BLC(-T)
- SFP-1GLHXLC(-T)
- SFP-1GZXLC(-T)
- SFP-1GEZXLC
- SFP-1GEZXLC-120

Certifications

ATEX Information	  II 3G Ex ec nC IIC T4 Gc UL 23 ATEX 3097X Ambient Range: -40 °C ≤ Tamb ≤ +75 °C for model suffix with "-T" Ambient Range: -10 °C ≤ Tamb ≤ +60 °C for model suffix without "-T" WARNING – DO NOT SEPARATE WHEN ENERGIZED Rated Cable Temp ≥ 88.7 °C
IECEX Certificate No.	IECEX UL 23.0076X
Address of Manufacturer	No. 1111, Heping Rd., Bade Dist., Taoyuan City 334004, Taiwan

Specific Usage Conditions

- The equipment shall be installed in an enclosure that provides a minimum ingress protection of IP54 in accordance with IEC/EN IEC 60079-0 and accessible only by the use of a tool.
- The equipment shall only be used in an area of at least pollution degree 2, as defined in IEC/EN 60664-1.



WARNING

사 용 자 안 내 문

이 기기는 업무용 환경에서 사용할 목적으로 적합성 평가를 받은 기기로서

가정용 환경에서 사용하는 경우 전과간섭의 우려가 있습니다.