

BXP-C100 Series Hardware User Manual

Version 1.1, December 2023

www.moxa.com/products



© 2023 Moxa Inc. All rights reserved.

BXP-C100 Series Hardware User Manual

The software described in this manual is furnished under a license agreement and may be used only in accordance with the terms of that agreement.

Copyright Notice

© 2023 Moxa Inc. All rights reserved.

Trademarks

The MOXA logo is a registered trademark of Moxa Inc.
All other trademarks or registered marks in this manual belong to their respective manufacturers.

Disclaimer

- Information in this document is subject to change without notice and does not represent a commitment on the part of Moxa.
- Moxa provides this document as is, without warranty of any kind, either expressed or implied, including, but not limited to, its particular purpose. Moxa reserves the right to make improvements and/or changes to this manual, or to the products and/or the programs described in this manual, at any time.
- Information provided in this manual is intended to be accurate and reliable. However, Moxa assumes no responsibility for its use, or for any infringements on the rights of third parties that may result from its use.
- This product might include unintentional technical or typographical errors. Changes are periodically made to the information herein to correct such errors, and these changes are incorporated into new editions of the publication.

Technical Support Contact Information

www.moxa.com/support

Table of Contents

1. Introduction	5
Package Checklist	5
Product Features	5
BXP-C100 Hardware Specifications.....	5
2. Hardware Introduction	6
Appearance.....	6
Dimensions	9
LED Indicators.....	11
Reset Button	11
Real Time Clock (RTC).....	11
3. Hardware Connection Description.....	12
Installing the BXP-C100.....	12
Connecting the Power	14
Communication Connections	15
Connecting to the Network	15
Connecting to a Serial Device	16
Digital Inputs/Digital Outputs.....	16
Connecting Displays.....	16
Connecting to a USB Device.....	17
Installing SD / CFast Card.....	17
Replacing the RTC Battery	17
4. BIOS Setup	20
Entering the BIOS Setup.....	20
Main Page.....	22
Advanced Settings	22
Boot Configuration.....	23
SATA Configuration	24
CPU Configuration	25
Video Configuration	26
Chipset Configuration.....	27
PCH-FW Configuration.....	28
Console Redirection	29
SIO ITE8786E.....	30
Hardware Monitor.....	31
Security Settings	32
Current TPM Device	32
TPM State.....	32
Clear TPM.....	32
Set Supervisor Password	33
Power Settings	35
Wake on LAN	35
Auto Wake on S5	35
Boot Settings	36
Network Stack	36
PXE Boot capability.....	36
USB Boot	37
Timeout	37
EFI	37
Exit Settings	38
Exit Saving Changes	38
Save Change Without Exit	38
Exit Discarding Changes.....	38
Load Optimal Defaults.....	38
Load Custom Defaults	39
Save Custom Defaults.....	39
Discard Changes	39
Enabling AMT	40
Using AMT	43

Administering Secure Boot.....	44
Enabling UEFI Secure Boot	44
Enroll EFI Image	45
Enroll Customer Key	46
Upgrading the BIOS	47
A. Regulatory Approval Statement.....	51

1. Introduction

The BXP-C100 wall-mount computers are powered by a 11th Gen Intel® Celeron® or Intel® Core™i5, or i7 processor. The computers come with a rich set of interface options including up to 10 software-selectable RS-232/422/485 serial ports, up to 10 gigabit Ethernet ports, 4 digital inputs, and 4 digital outputs. The communication interfaces are located on the front and rear sides of the product, enabling easy access and expansion for industrial applications. A dual-storage design that includes CFast and SD slots enables easy storage expansion. The unique battery fastener cover design for the battery slot secures the battery in place and ensures stability in all operating environments.

Package Checklist

Each model is shipped with the following items:

- BXP-C100 Series computer
- Wall mounting kit
- 2-pin terminal block for DC power
- 10-pin terminal block for DI/DO
- Quick installation guide (printed)
- Warranty card



NOTE

Please notify your sales representative if any of the above items are missing or damaged.

Product Features

BXP-C100 computers include the following features:

- Box type computer with fanless design
- 11th Gen Intel® Core™ Processors
- Rich interface options for up to 10 serial ports or up to 10 LAN ports.
- -30 to 60°C wide-temperature design
- Compact size that fits multiple field applications

BXP-C100 Hardware Specifications



NOTE

The latest specifications for Moxa's products can be found at <https://moxa.com>.

2. Hardware Introduction

The BXP-C100 Series wall-mount computers are compact, well-designed, and rugged enough for industrial applications. LED indicators help you monitor performance and identify trouble spots, multiple serial ports allow you to connect different devices for wireless operation, and the reliable and stable hardware platform lets you devote your attention to developing your applications.

Appearance

Front View

BXP-C100-C1-T/BXP-C100-C5-T/BXP-C100-C7-T Models

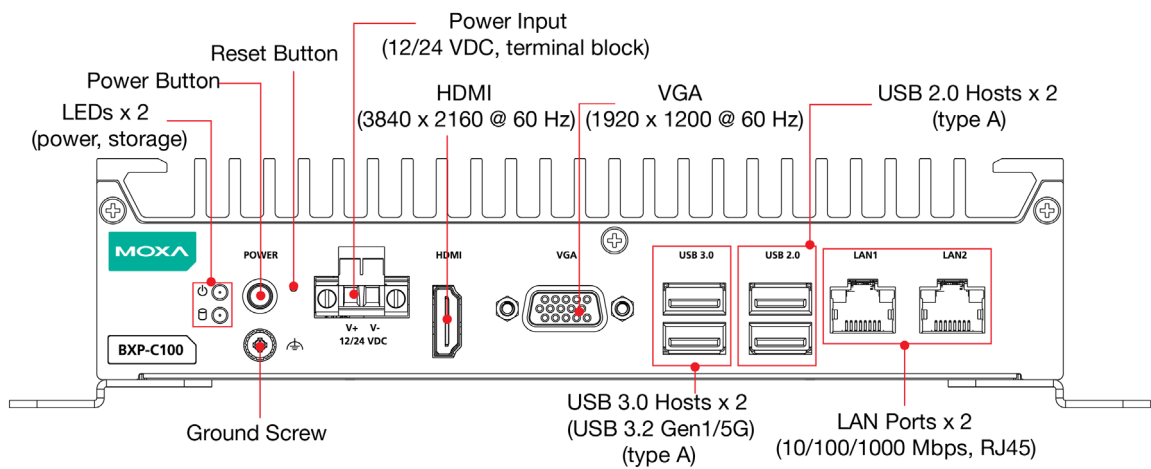

BXP-C100-C1-8L-T/BXP-C100-C5-8L-T/BXP-C100-C7-8L-T Models

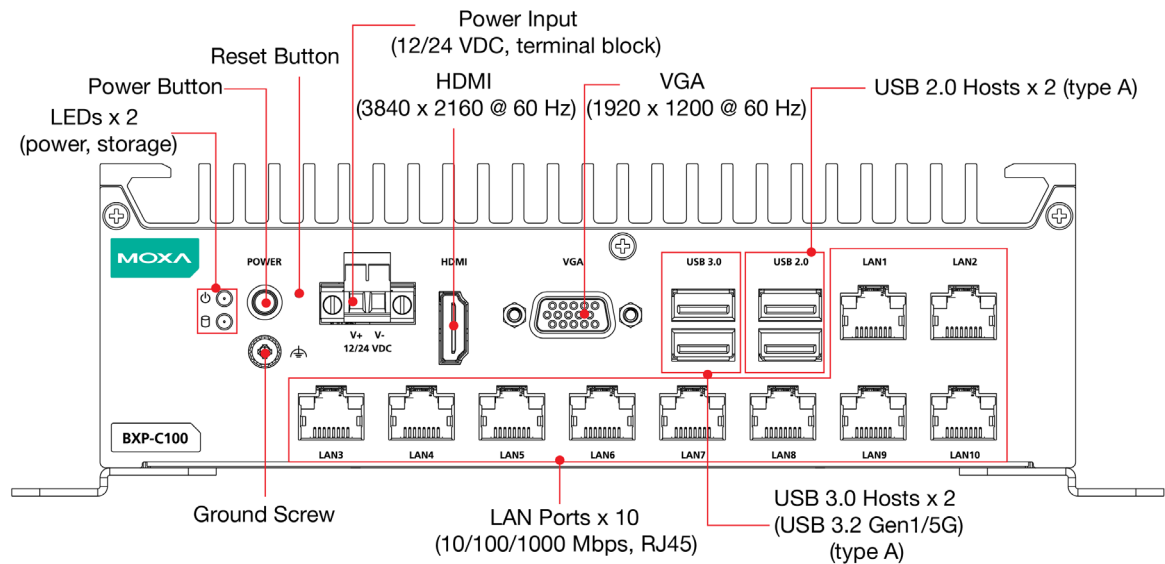

BXP-C100-C1-8C-T/BXP-C100-C5-8C-T/BXP-C100-C7-8C-T Models

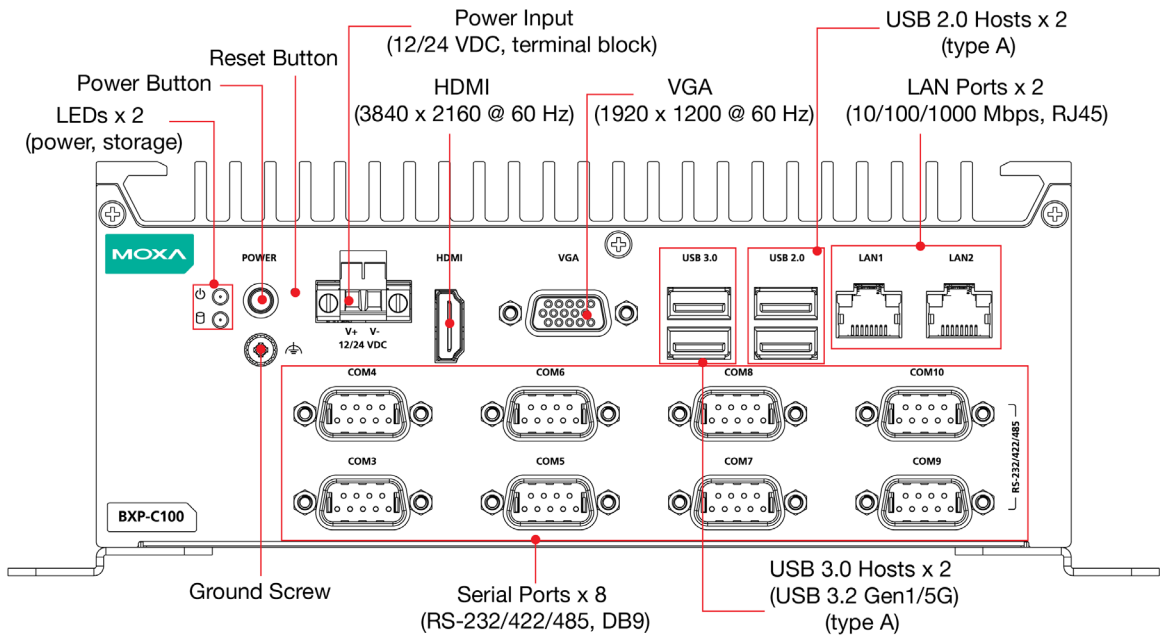

BXP-C100-C1-2L3C-T/BXP-C100-C5-2L3C-T/BXP-C100-C7-2L3C-T Models

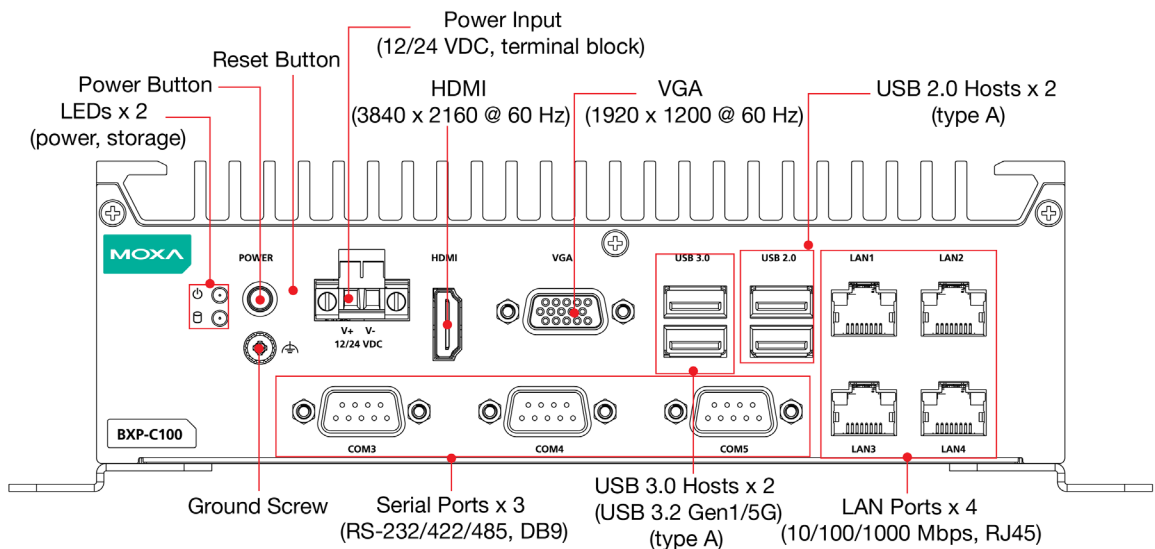

Rear View

BXP-C100-C1-T/BXP-C100-C5-T/BXP-C100-C7-T

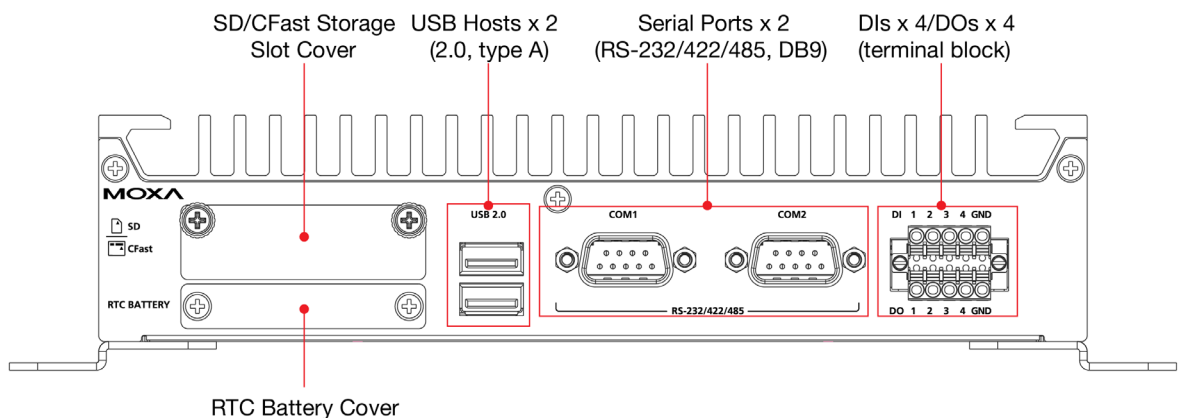

BXP-C100-C1-8L-T/BXP-C100-C5-8L-T/BXP-C100-C7-8L-T

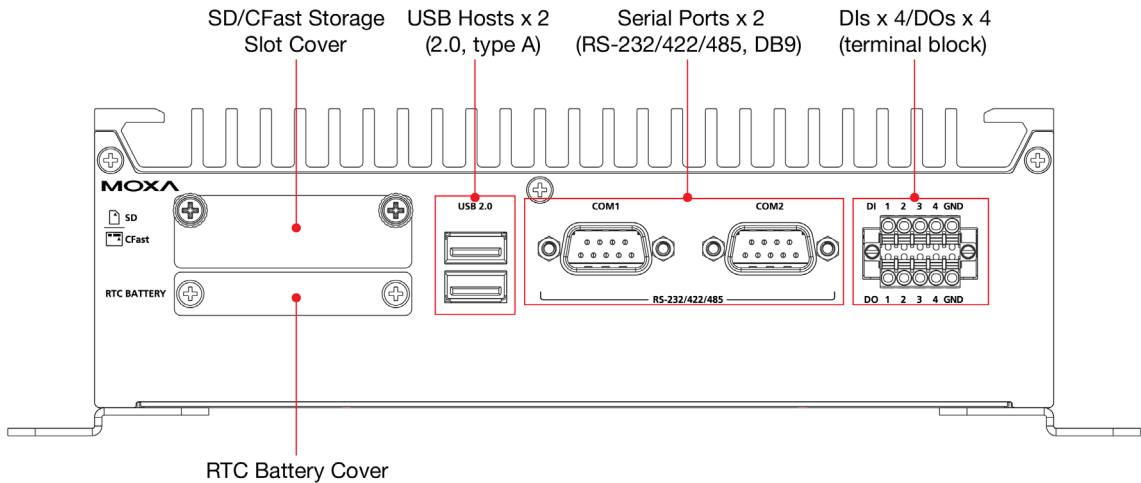

BXP-C100-C1-8C-T/BXP-C100-C5-8C-T/BXP-C100-C7-8C-T

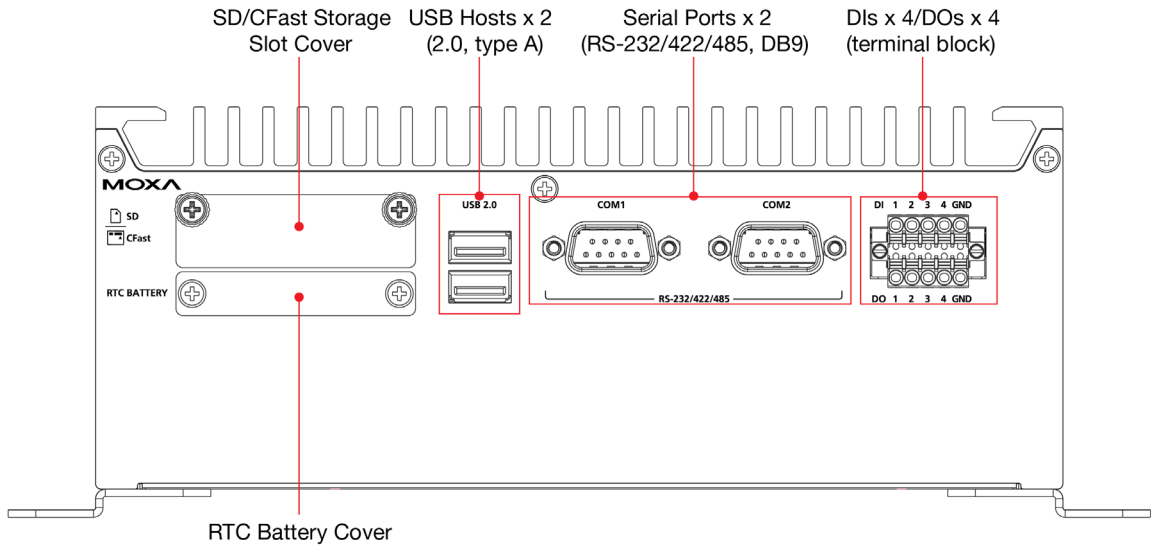

BXP-C100-C1-2L3C-T/BXP-C100-C5-2L3C-T/BXP-C100-C7-2L3C-T

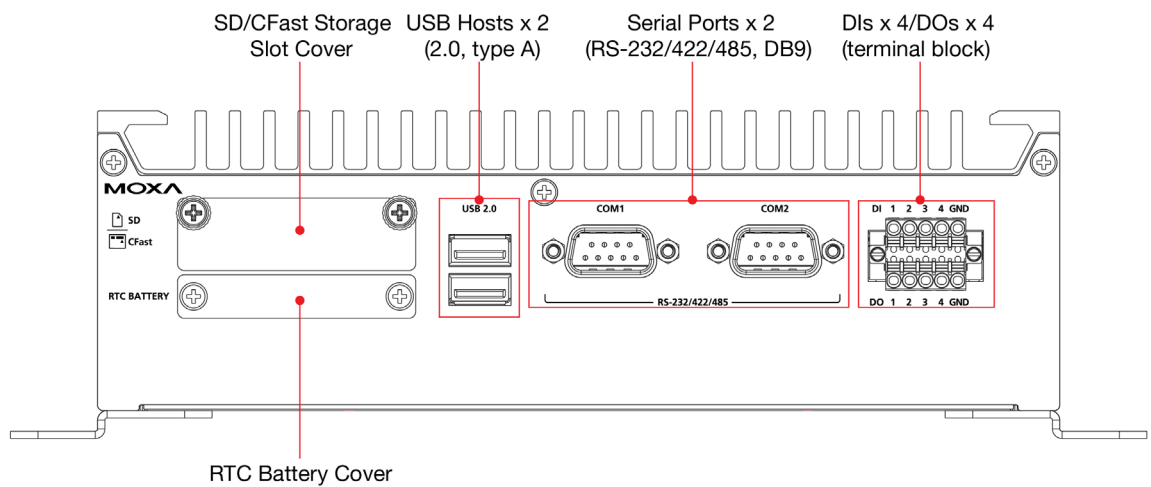

Dimensions

BXP-C100-C1-T/BXP-C100-C5-T/BXP-C100-C7-T Models

Unit: mm (inch)

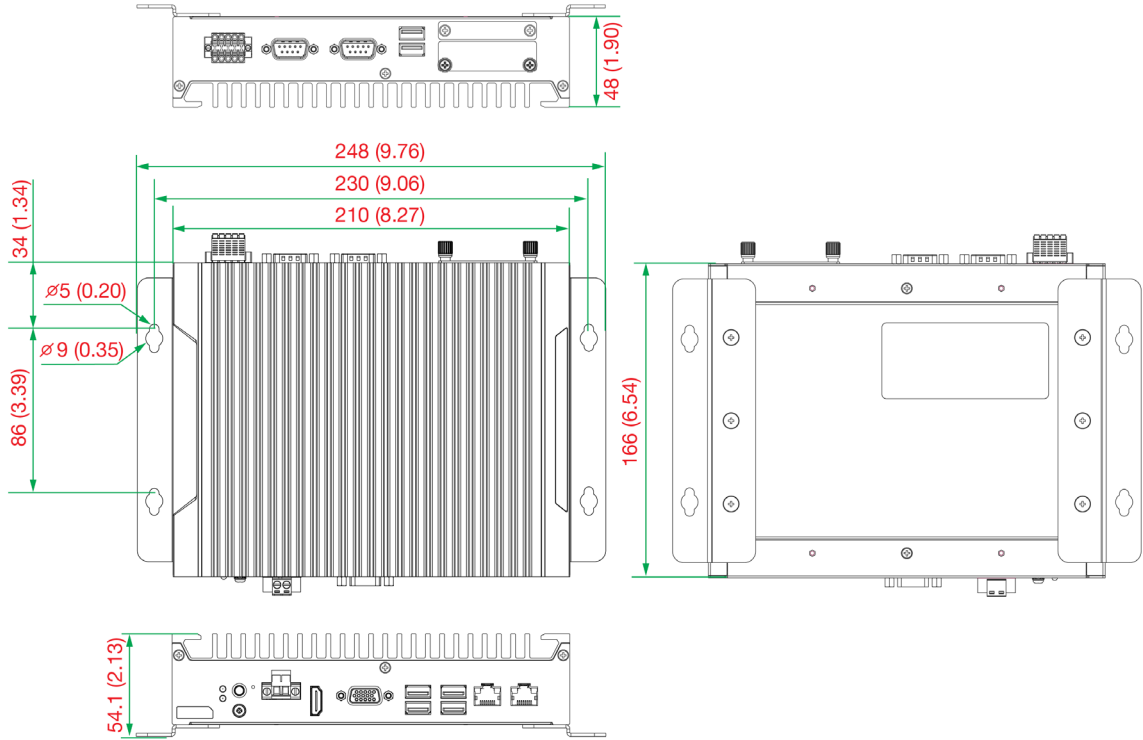

BXP-C100-C1-8L-T/BXP-C100-C5-8L-T/BXP-C100-C7-8L-T Models

Unit: mm (inch)

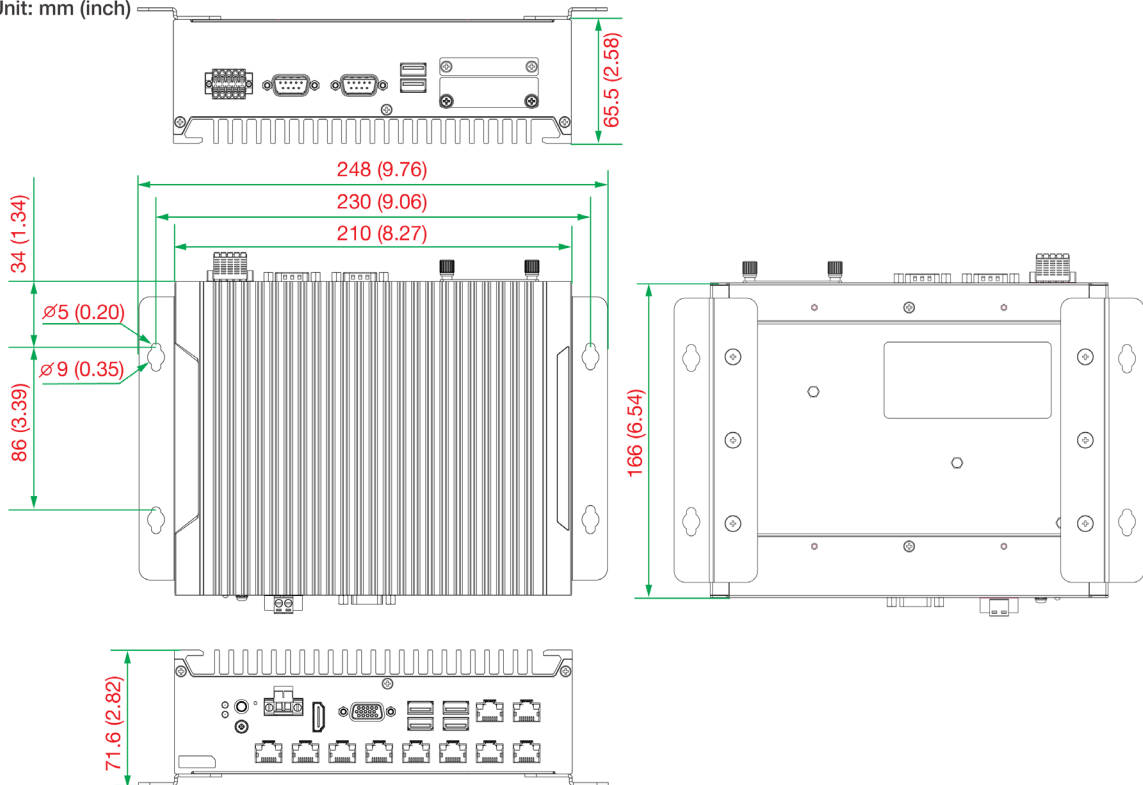

BXP-C100-C1-8C-T/BXP-C100-C5-8C-T/BXP-C100-C7-8C-T Models

Unit: mm (inch)

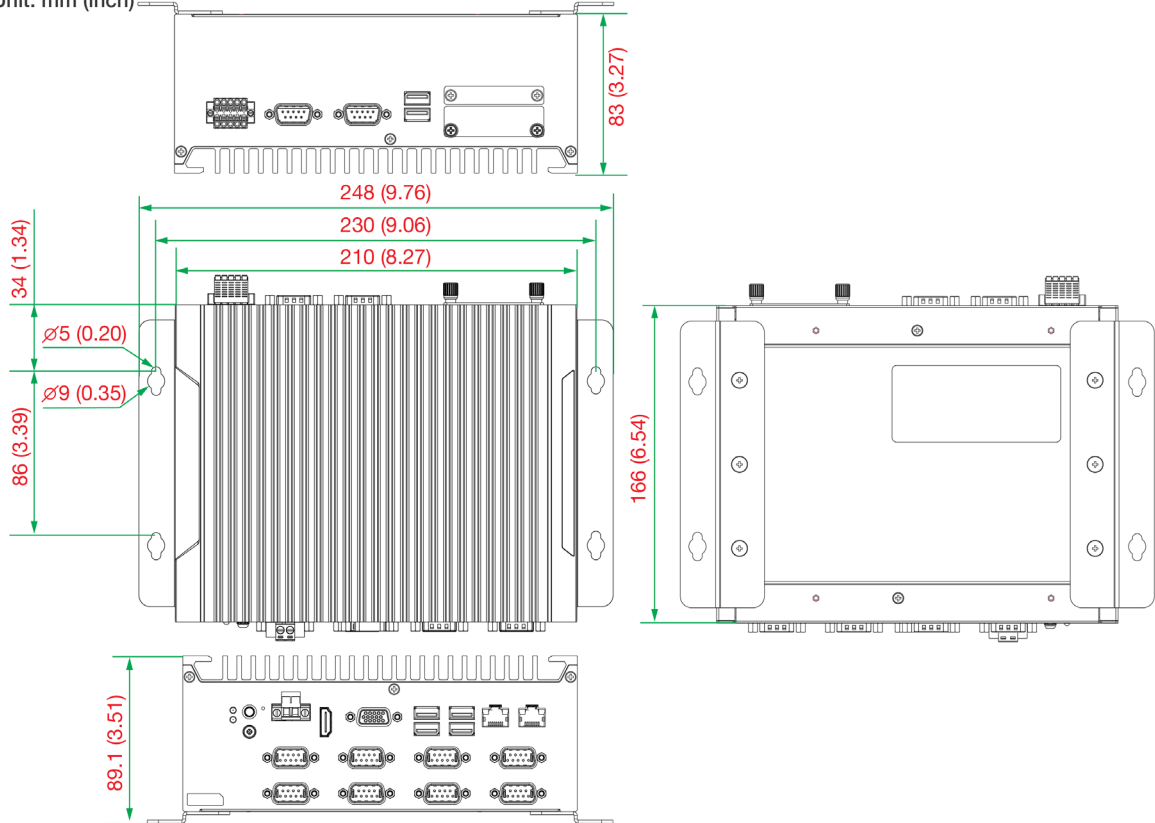

BXP-C100-C1-2L3C-T/BXP-C100-C5-2L3C-T/BXP-C100-C7-2L3C-T Models

Unit: mm (inch)

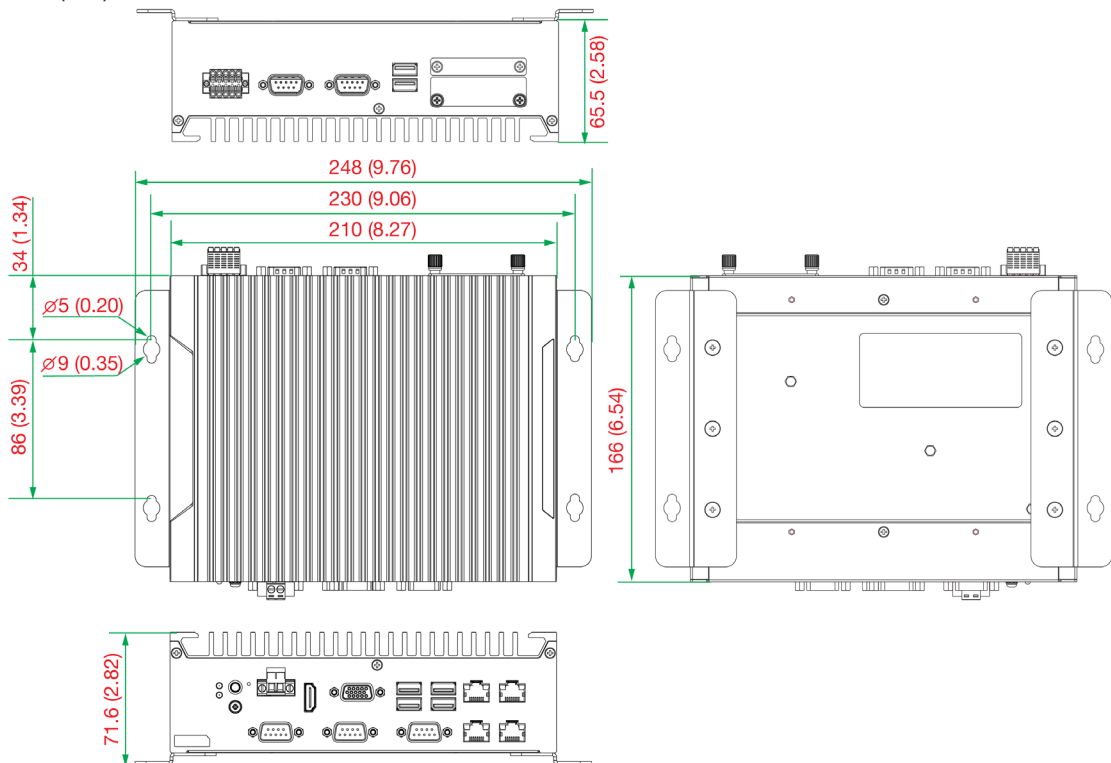

LED Indicators

The following table describes the LED indicators located on the front panel of BXP-C100 computers.

LED Name	LED Color	LED Function
Power	Green	Power is ON
	OFF	No power input or any other power error
Ethernet (10/100 Mbps) (1000 Mbps)	Green	Steady ON: 10/100 Mbps Ethernet link Blinking: Data is being transmitted or received
	Yellow	Steady ON: 1000 Mbps Ethernet link Blinking: Data is being transmitted or received
	OFF	No Ethernet connection
Storage (CFast)	Yellow	Blinking: Data is being accessed from the CFast card
	OFF	Data is not being accessed from the CFast card

Reset Button

Press the Reset button on the front panel of the computer to reboot the system. Pushing the Reset button will restart the system immediately and any unsaved data will be lost.



NOTE

The BXP-C100 does not support a reset-to-default function.

Real Time Clock (RTC)

The BXP-C100's real-time clock is powered by a lithium battery. You can easily replace the battery yourself using an optional battery kit. Refer to the Replacing the RTC Battery section for details. However, please note that there is a risk of explosion if the battery is replaced by an incorrect type of battery. Contact a qualified Moxa support engineer if you have questions or need help replacing the RTC battery.



ATTENTION

There is a risk of explosion if the battery is replaced by a battery of the incorrect type.

3. Hardware Connection Description

In this chapter, we describe how to connect the BXP-C100 to the network and to various devices.

Installing the BXP-C100

The BXP-C100 computer comes with two wall-mounting brackets. Attach the brackets to the computer using three screws on each side as indicated in the diagram.

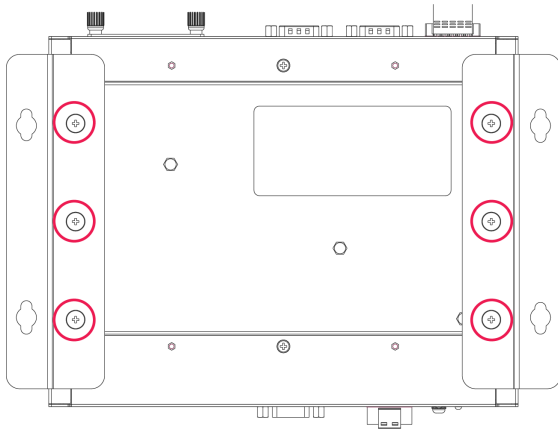

Fastening Torque: 10Kgf-cm

The six screws for the mounting brackets are included in the product package. Refer to the following illustrations for detailed specifications.

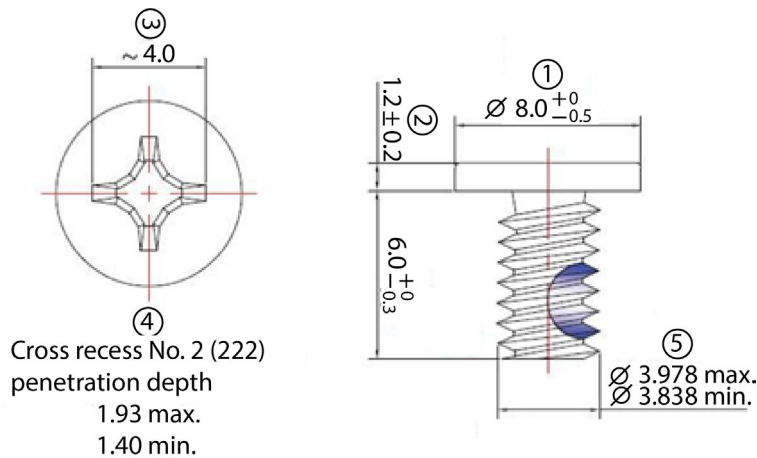

To mount a BXP-C100 computer to a wall or cabinet, use two screws on each side for the mounting brackets as shown in the illustration.



NOTE

The four screws for attaching the wall-mounting brackets to the wall or cabinet are NOT included in the product package; they need to be purchased separately.

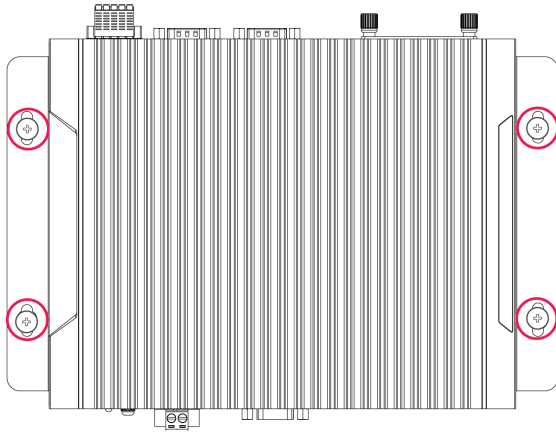

The specifications of the 4 screws to be purchased separately is indicated in the diagram.

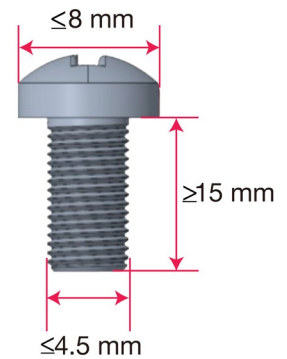

After mounting the BXP-C100 computer using the wall-mounting kit and fastening the 4 screws to fix the mounting brackets to the wall or cabinet, push the computer downwards to ensure that the device is secured firmly to the mounting surface.

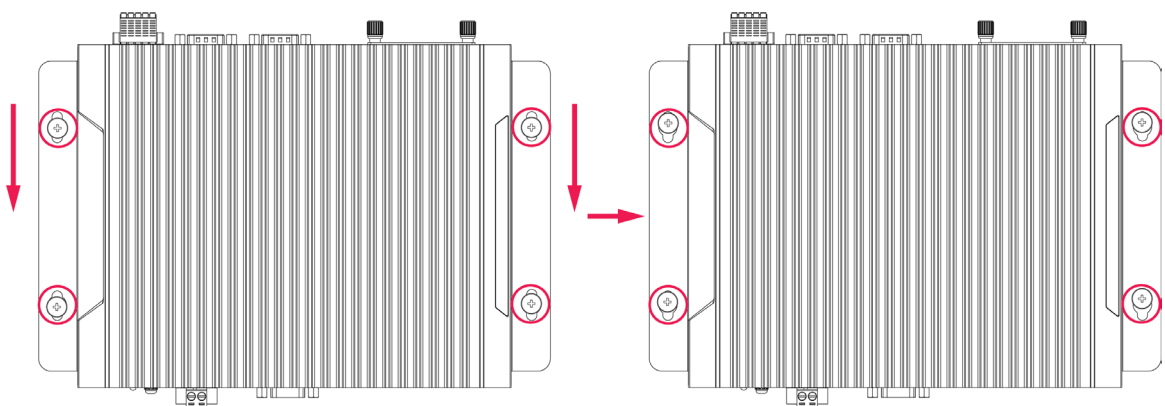

NOTE

This computer is intended to be installed only in an area with restricted access. In addition, for safety reasons, the computer should be installed and handled only by qualified and experienced professionals.



ATTENTION

Safety First!

Be sure to disconnect the power cord before installing and/or wiring your BXP-C100.

Wiring Caution!

Calculate the maximum possible current in each power wire and common wire. Observe all electrical codes dictating the maximum current allowable for each wire size. If the current goes above the maximum ratings, the wiring could overheat, causing serious damage to your equipment.

Temperature Caution!

Be careful when handling the unit. When the unit is plugged in, the internal components generate heat, and consequently the outer casing may feel hot to the touch.

Connecting the Power

The BXP-C100 computer is provided with 2-pin power input connectors in a terminal block on the front panel. Insert the power-cord wires into the connectors and tighten them to secure the wires in place. Push the power button. The power LED will light up to indicate that power is being supplied to the computer. It should take about 30 to 60 seconds for the operating system to complete the boot-up process.

Pin	Definition
1	V+
2	V-

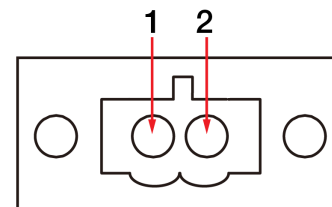

V+ V-
12/24 VDC

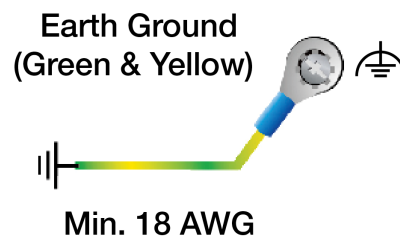

The power input specification is given below:

- The DC power source rating is 12 VDC @ 6.65 A or 24 VDC @ 3.30 A
- A minimum wire gauge of 18 AWG is required.

For surge protection, connect the grounding connector located below the power connector with the earth (ground) or a metal surface.



NOTE

This computer is intended to be supplied by a UL Listed Power Unit "LPS" (or "Limited Power Source") rated 12 V @ 6.65 A min., 24 V @ 3.30 A min., and minimum T_{ma} = 60°C. If you need assistance with purchasing a power adapter, contact the Moxa technical support team.



NOTE

If using Class I adapter, the power cord adapter should be connected to a socket outlet with an earthing connection or the power cord and adapter must comply with Class II construction.



ATTENTION

Before connecting the BXP-C100 computer to the DC power inputs, make sure the DC power source voltage is stable.

- The wiring for the input terminal block shall be installed by a skilled person.
- Wire type: Cu
- Only use 18-12 AWG wire size and a torque value of 0.5 N-m.
- Use only one conductor in a clamping point between the DC power source and the power input.



警告

為避免電磁干擾，本產品不應安裝或使用於住宅環境。

Communication Connections

Connecting to the Network

Connect your network cable to the computer's Ethernet port. The other end of the cable should be connected to your Ethernet network. When the cable is properly connected, the LEDs on the computer's Ethernet port turn on to indicate a valid connection.

The BXP-C100 computer has 2, 4, or 10 10/100/1000 Mbps Ethernet ports with RJ45 connectors on the front panel. Refer to the following table for the pin assignments:



Pin	10/100 Mbps	1000 Mbps
1	ETx+	TRD(0)+
2	ETx-	TRD(0)-
3	ERx+	TRD(1)+
4	-	TRD(2)+
5	-	TRD(2)-
6	ERx-	TRD(1)-
7	-	TRD(3)+
8	-	TRD(3)-



NOTE

For reliable Ethernet connections, we recommend enabling the ports in standard temperatures and keeping them enabled in high/low temperature environments.

Connecting to a Serial Device

Use a serial cable to connect your serial device to the computer's serial port. The BXP-C100 computer comes with 2 software-selectable RS-232/422/485 serial ports on the rear panel. Additional serial ports are located on the front panel. The ports use DB9 male connectors. The pin assignments are shown in the following table:

DB9 Male Port

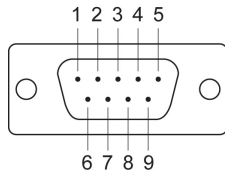

RS-232/422/485 Pinouts

Pin	RS-232	RS-422	RS-485 (4-wire)	RS-485 (2-wire)
1	DCD	TxDA(-)	TxDA(-)	-
2	RxD	TxDB(+)	TxDB(+)	-
3	TxD	RxDB(+)	RxDB(+)	DataB(+)
4	DTR	RxDA(-)	RxDA(-)	DataA(-)
5	GND	GND	GND	GND
6	DSR	-	-	-
7	RTS	-	-	-
8	CTS	-	-	-

Digital Inputs/Digital Outputs

The BXP-C100 comes with four digital inputs and four digital outputs in a terminal block. Refer to the following figure for the pin definitions and the current ratings.

DI 1 2 3 4 GND

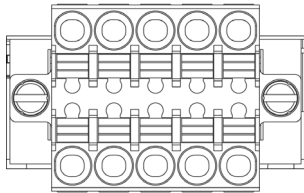

DO 1 2 3 4 GND



Digital Inputs

Dry Contact:
Logic 0: Short to Ground
Logic 1: Open

Digital Outputs

Current Rating: 200 mA per channel
Voltage: 0 to 24 VDC

DI Dry Contact

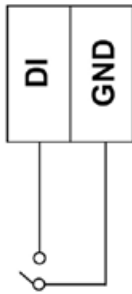

DO Contact Sink

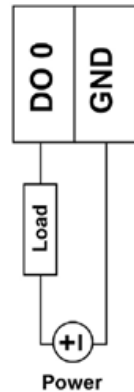

Connecting Displays

The BXP-C100 computer comes with a VGA and an HDIM display output located on the front panel.



NOTE

For reliable video streaming, use premium HDMI-certified cables.

Connecting to a USB Device

The BXP-C100 computer comes with 2 USB 3.0 ports and 2 USB 2.0 ports on the front panel. An additional 2 USB 2.0 ports are located on the rear panel. The USB ports can be used to connect to peripherals, such as keyboard, mouse, or flash drives for expanding the system's storage capacity.

Installing SD / CFast Card

The BXP-C100 computer comes with two slots for plugging in an SD card and a CFast card.

To plug in the cards, do the following:

1. Remove the two screws that secure the slot cover.



2. Remove the cover and locate the SD and CFast card slots.

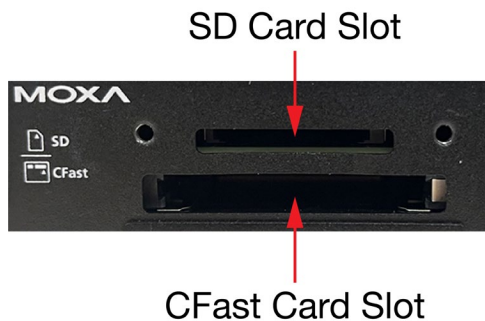

3. Insert the SD and CFast cards in the designated slots. Refer to the image printed beside the slots for the correct direction to insert the cards. When the cards are successfully inserted, you will hear a click.
4. To remove the cards, simply push them in to release them and take them out.

Replacing the RTC Battery

The BXP-C100 computer comes with one slot for a battery on the rear panel of the computer. A lithium battery (3 V / 200 mAh) is preinstalled in the slot.

To replace the battery, do the following:

1. Unfasten the two screws on the battery cover.

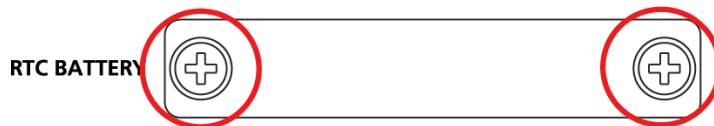

2. Take off the cover. The battery is attached to the slot cover as indicated in the image.

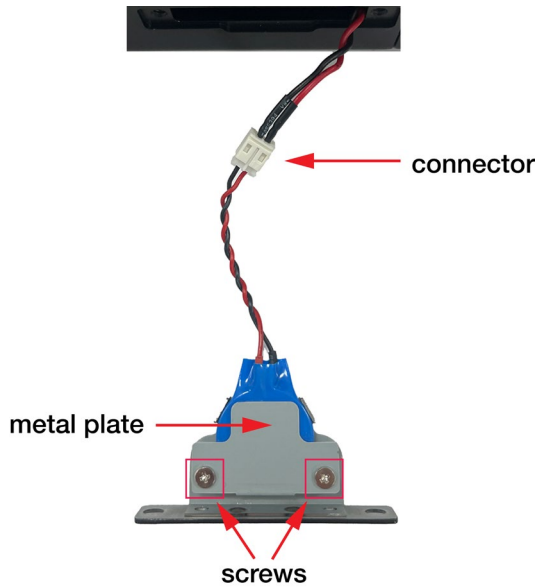

3. Unplug the connector of the battery-cover assembly from the internal wire of the slot.
4. Remove the two screws on the metal plate attached to the battery holder.



5. Place a new battery in the battery holder, replace the metal plate, and fasten the two screws on to the frame to secure the battery.

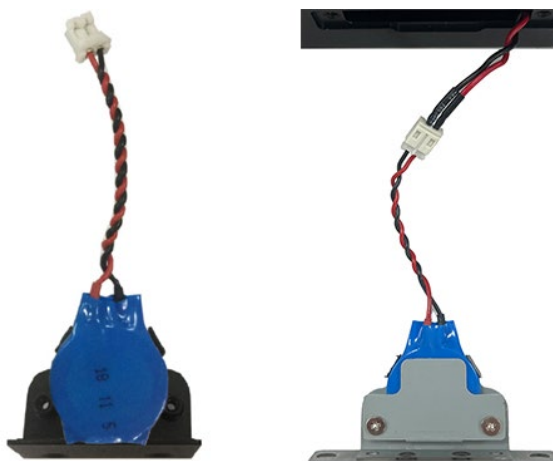

6. Plug in the connector of the battery-cover assembly to the internal wire of the slot.
7. Place the battery holder back in the slot and secure it by fastening the two screws on the cover.



WARNING

- Be sure to use the correct type of battery. Incorrect battery may cause system damage. Contact Moxa's technical support staff for assistance, if necessary.
- To reduce the risk of fire or burns, do not disassemble, crush, or puncture the battery; do not dispose of in fire or water and do not short external contacts.

4. BIOS Setup

In this chapter, we describe the BIOS settings for the BXP-C100 computer. The BIOS is a set of input/output control routines for peripherals to initialize the basic settings. The BIOS helps boot the system before the operating system is loaded. The BIOS setup allows the user to modify the system configuration for basic input/output peripherals. All the configurations are stored in the CMOS RAM, which has a backup battery in case the computer is not connected to a power source. Consequently, the data stored in the CMOS RAM is retained when the system is rebooted, or the power is disconnected.

Entering the BIOS Setup

To enter the BIOS setup utility, press the F2 key while the system is booting up. The main BIOS Setup screen will appear. You can configure the following settings on this screen.

- **Continue:** Continue to boot up
- **Boot Manager:** Select the device for boot up
- **Device Management:** Enter the device configuration menu
- **Boot From File:** Select the UEFI boot up file
- **Administer Secure Boot:** Enter the Secure Boot menu
- **Setup Utility:** Enter the BIOS configuration menu
- **Intel® Management Engine BIOS Extension:** Enter the AMT configuration menu (not supported in models with Intel® Celeron® and Core™ i3 processors)

Select **F2** to enter the **BIOS configuration**.

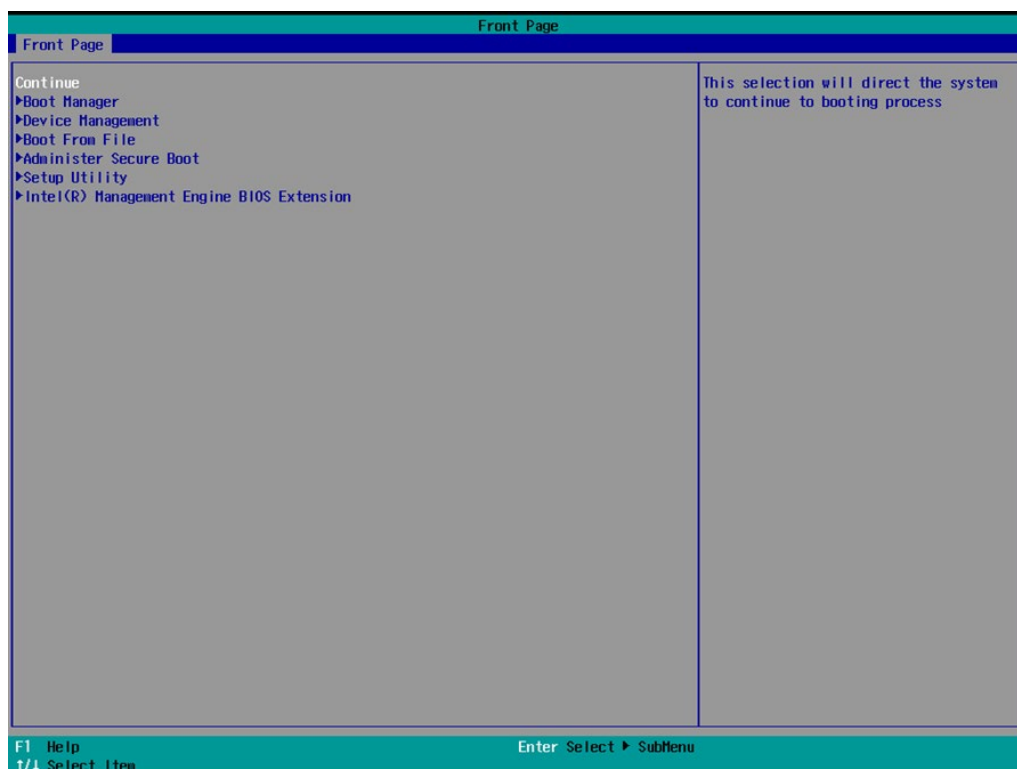

When you enter the **Setup Utility**, a basic description of each function key is listed at the bottom of the screen. Refer to these descriptions to learn how to use them.

F1	General Help	↑ ↓ .	Select Item
F5/ F6	Change Values	← →	Select Menu
F9	Setup Defaults	ESC	Exit
F10	Save and Exit	EN TER	Select or go to Submenu.

The BIOS configuration screen will be shown when you enter the **Setup Utility** option.

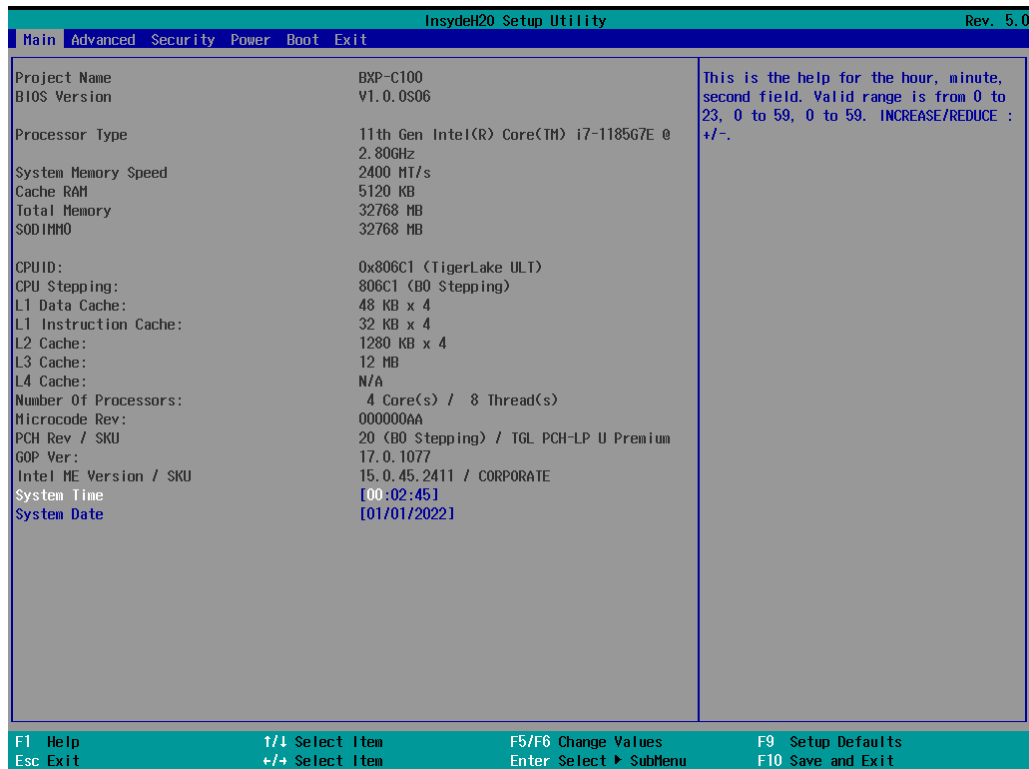

NOTE

The **Processor Type** information may vary depending on the model that you have purchased.

Main Page

The **Main** page displays basic hardware information, such as model name, BIOS version, and CPU type.

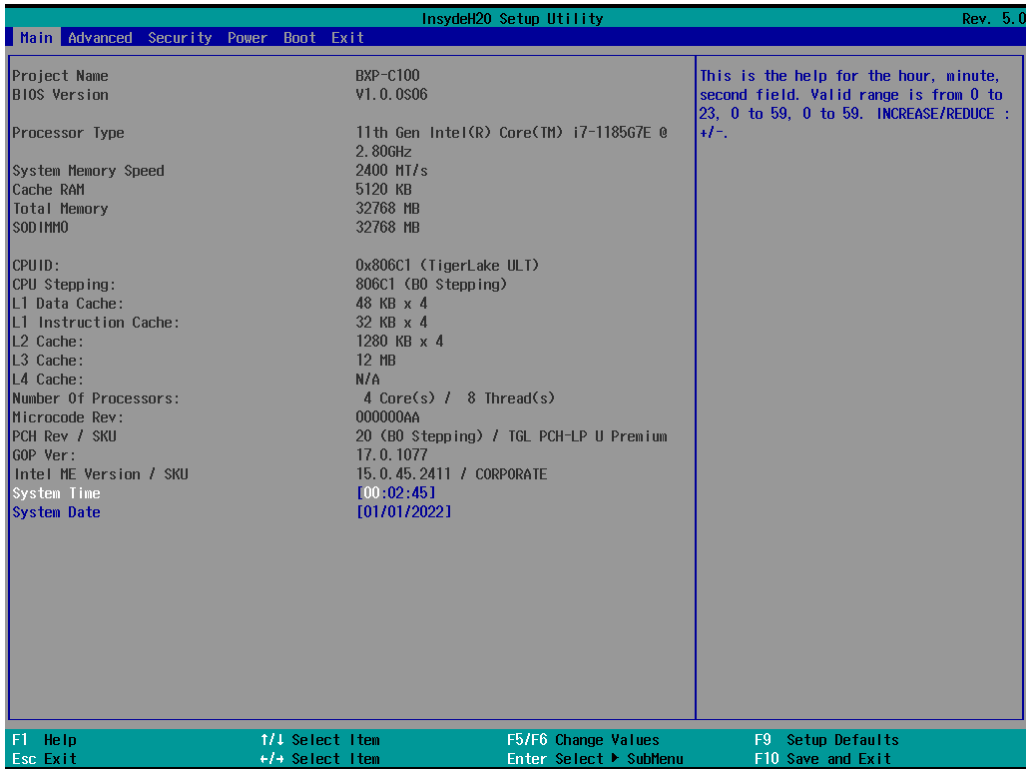

Advanced Settings

Select the **Advanced** tab in the main menu to open the advanced features screen.

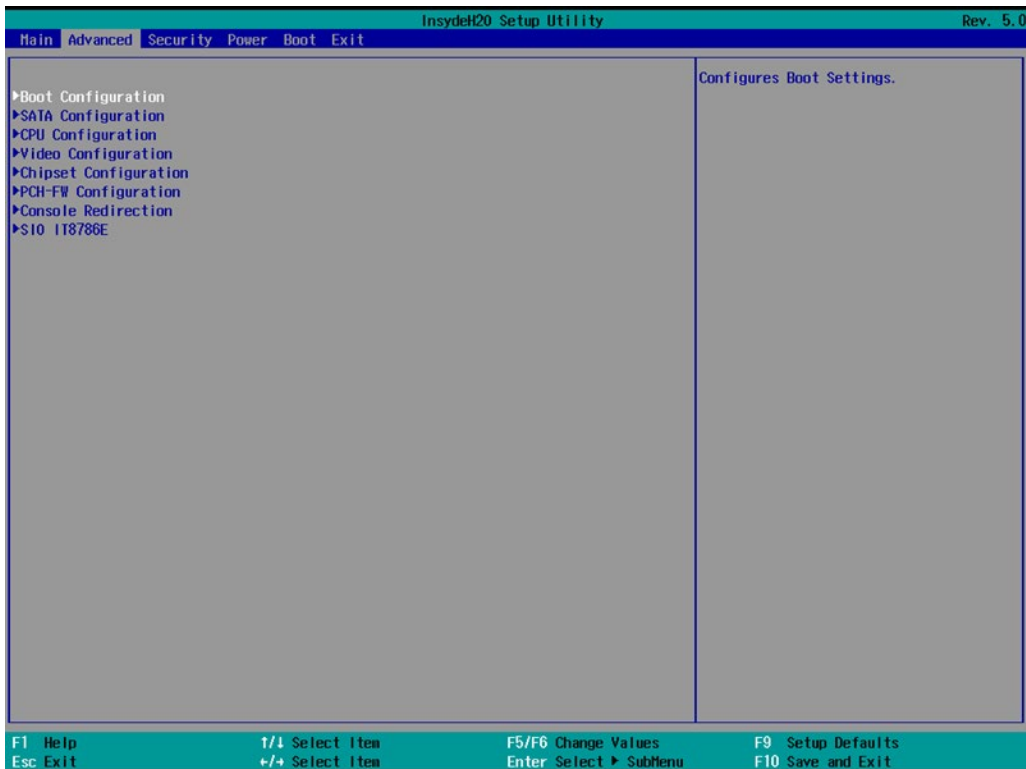

Boot Configuration

The **Numlock** option allows configuration of the Numlock value.

Options: On (default), Off.

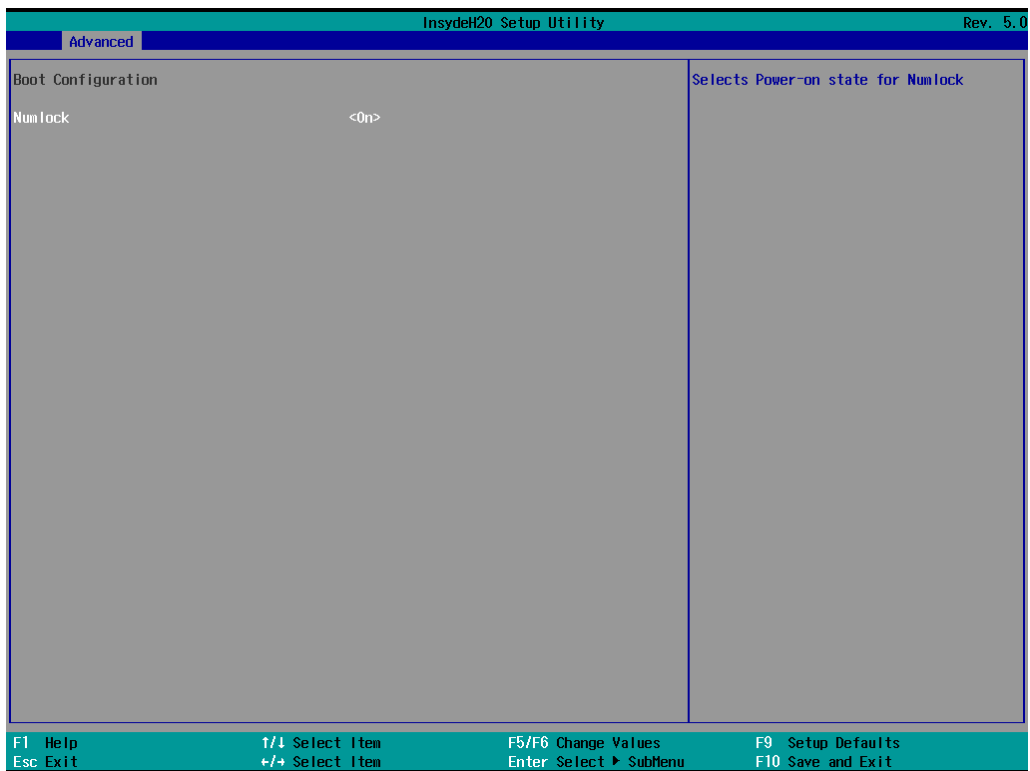

SATA Configuration

This section allows you to select the SATA speed limit and hot plug setting.

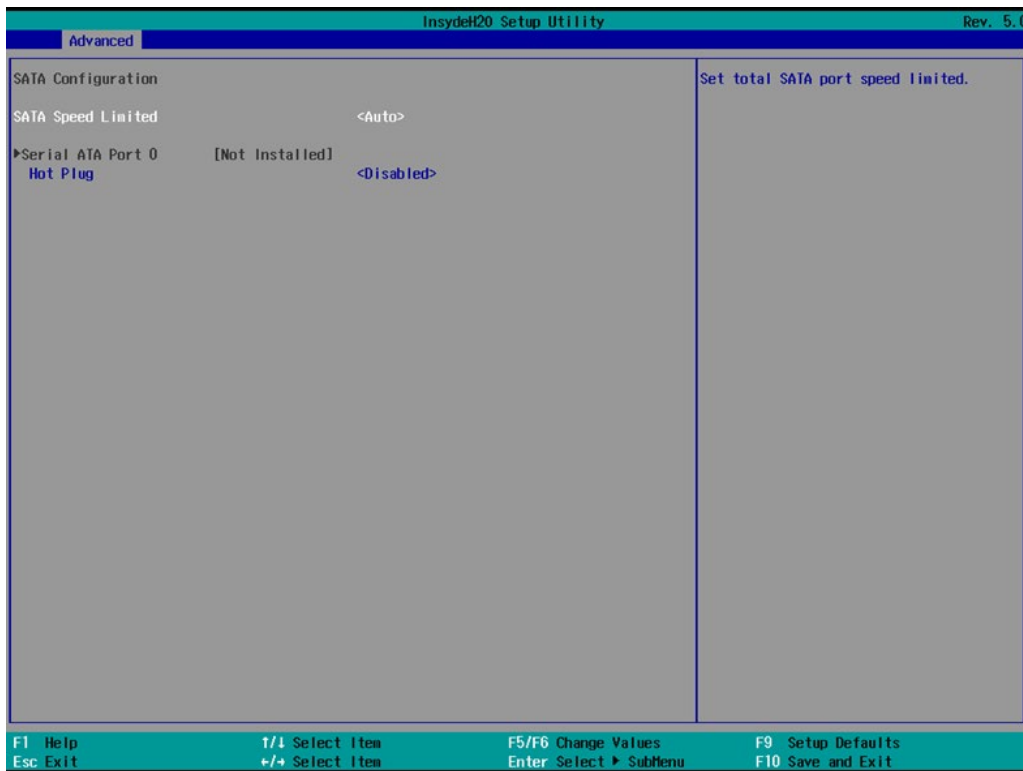

SATA Speed Limited

Options: Auto (default), Gen 1, Gen 2, Gen 3

Serial ATA Port

This setting displays information on the installed drives.

SATA Port Hot Plug

This setting allows you to enable/disable hot-plugging capabilities (the ability to remove the drive while the computer is running) that are configured by software for installed storage drives.

Options: Disabled (default), Enabled

CPU Configuration

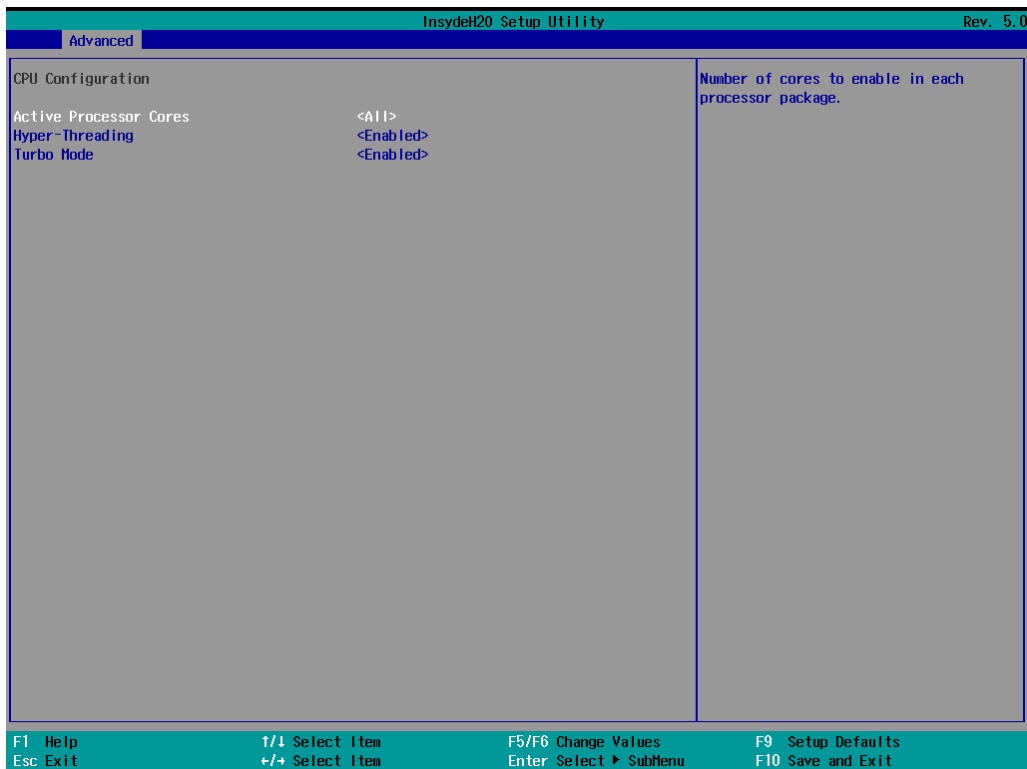

Active Processor Cores

This item indicates the number of cores to enable in each processor package (Cores number depended on the processor).

Options: All (default), 1, 2, 3

Hyper-Threading

This feature makes the processor resources work more efficiently, enabling multiple threads to run on each core. It also increases processor throughput, improving overall performance on threaded software.

Options: Disabled, Enabled (default)

Turbo Mode

Enable/Disable processor Turbo Mode (not supported in models with Intel® Celeron®).

Options: Disabled, Enabled (default)

Video Configuration

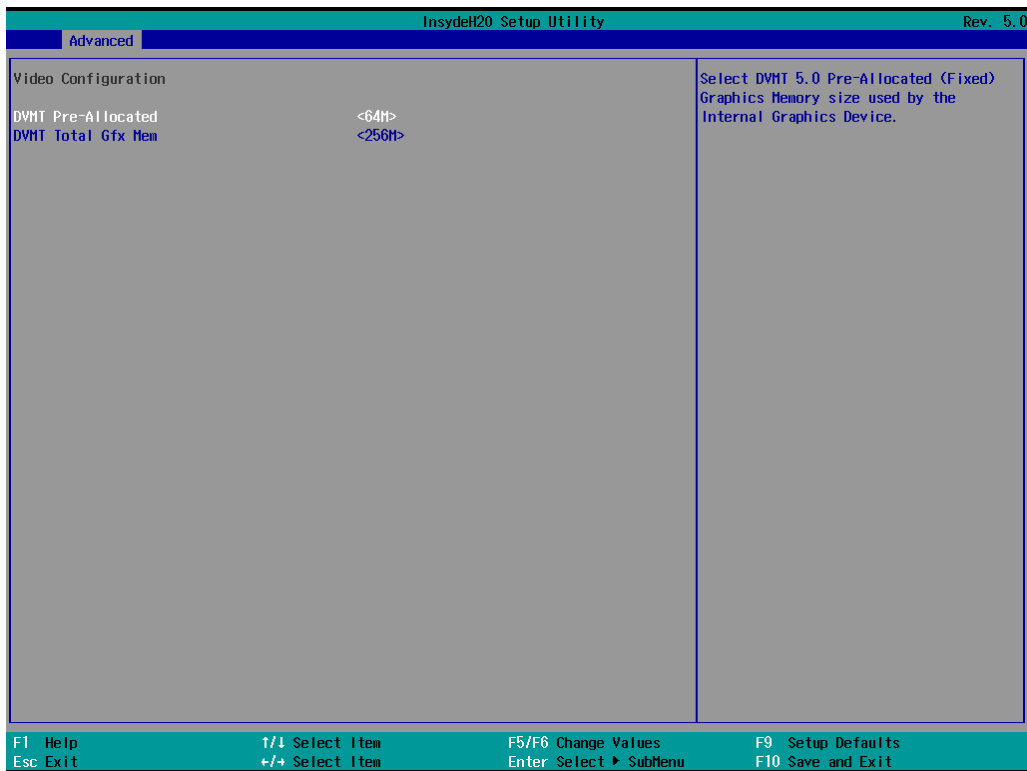

DVMT Pre-Allocated

This item allows you to configure pre-allocated memory capacity for the IGD. Pre-allocated graphics memory is invisible to the operating system.

Options: 64M (default), 96M, 128M, 160M

DVMT: The amount of video memory your computer has is dependent on the amount of pre-allocated memory set for your system plus the Dynamic Video Memory Technology (DVMT). DVMT dynamically allocates system memory for use as video memory creating the most efficient use of available resources for maximum 2D/3D graphics performance.

DVMT Total Gfx Mem.

This item allows you to configure the maximum amount of memory DVMT will use when allocating additional memory for the internal graphics device.

Options: 256 MB (default), 128 MB, Max.

Chipset Configuration

This section allows you to configure the chipset settings.

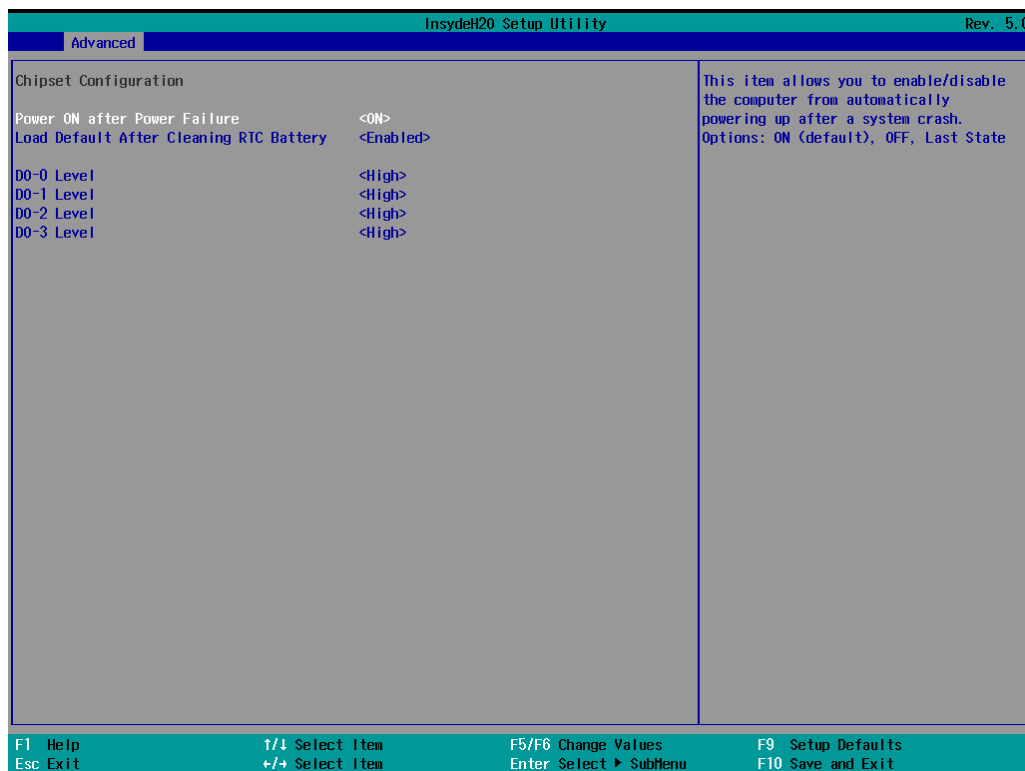

Power ON after Power Failure

This item allows you to enable/disable the computer from automatically powering up after system power is re-enabled.

Options: ON (default), OFF, Last State

Load Default After Cleaning RTC Battery

System will load default when detecting RTC battery loss.

Options: Disabled, Enabled (default)

DO-X Level

This item allows users to set the DO to high or low.

Options: High (default), Low

PCH-FW Configuration

This section allows you to configure the PCH-FW settings.

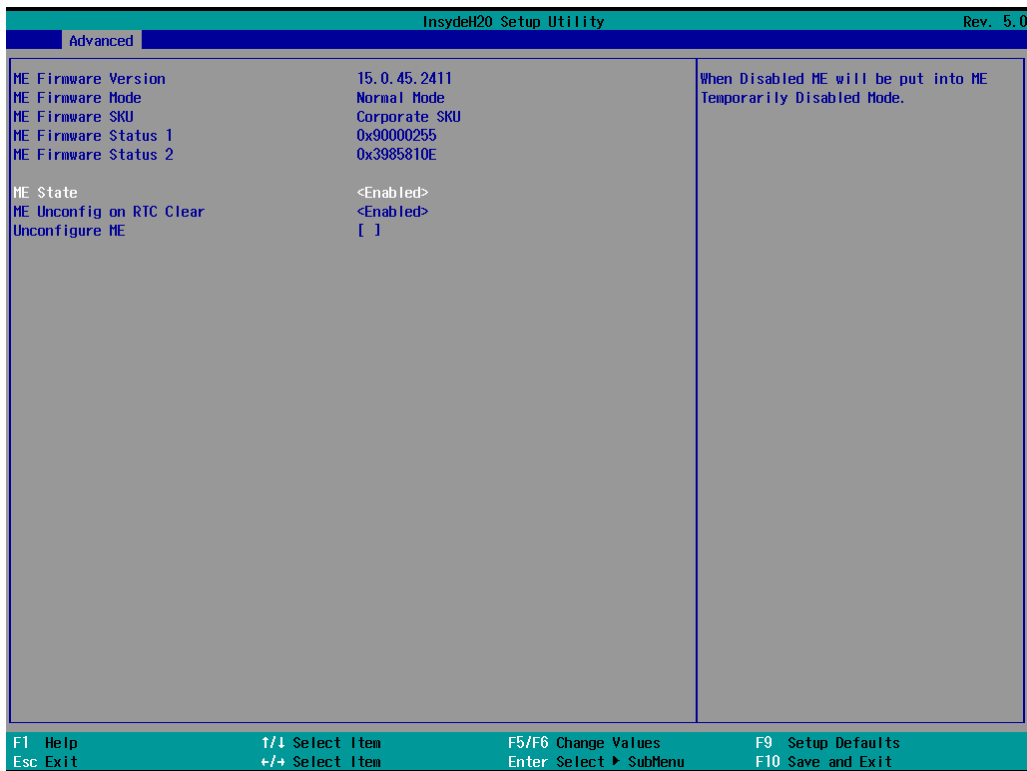

ME State

When Disabled ME will be put into ME Temporarily Disabled Mode.

Options: Disabled, Enabled (default)

ME Unconfig on RTC Clear

When Disabled ME will not be unconfigured on RTC Clear.

Options: Disabled, Enabled (default)

Unconfigure ME

Unconfigure ME by resetting MEBx password to default.

Console Redirection

This section allows you to configure the console redirection settings.

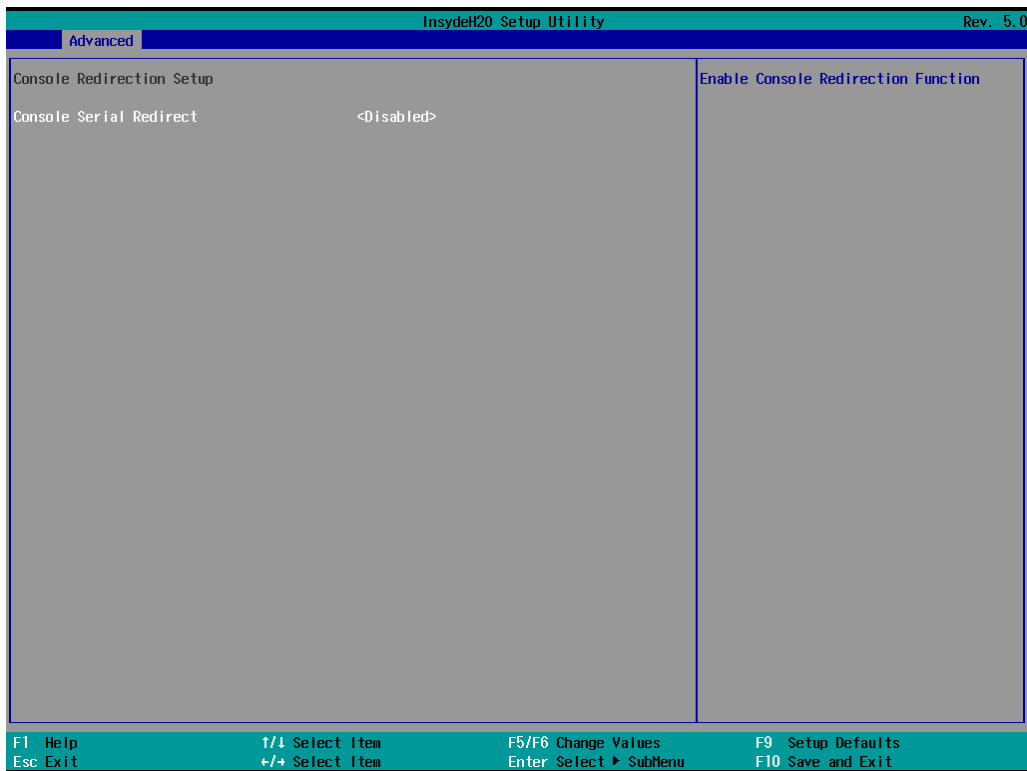

Console Serial Redirect

When the Console Redirection Function is enabled, the console information will be sent both to the display monitor and the serial port (COM1).

Options: Disabled (default), Enabled

SIO ITE8786E

This section allows users to configure SIO settings.

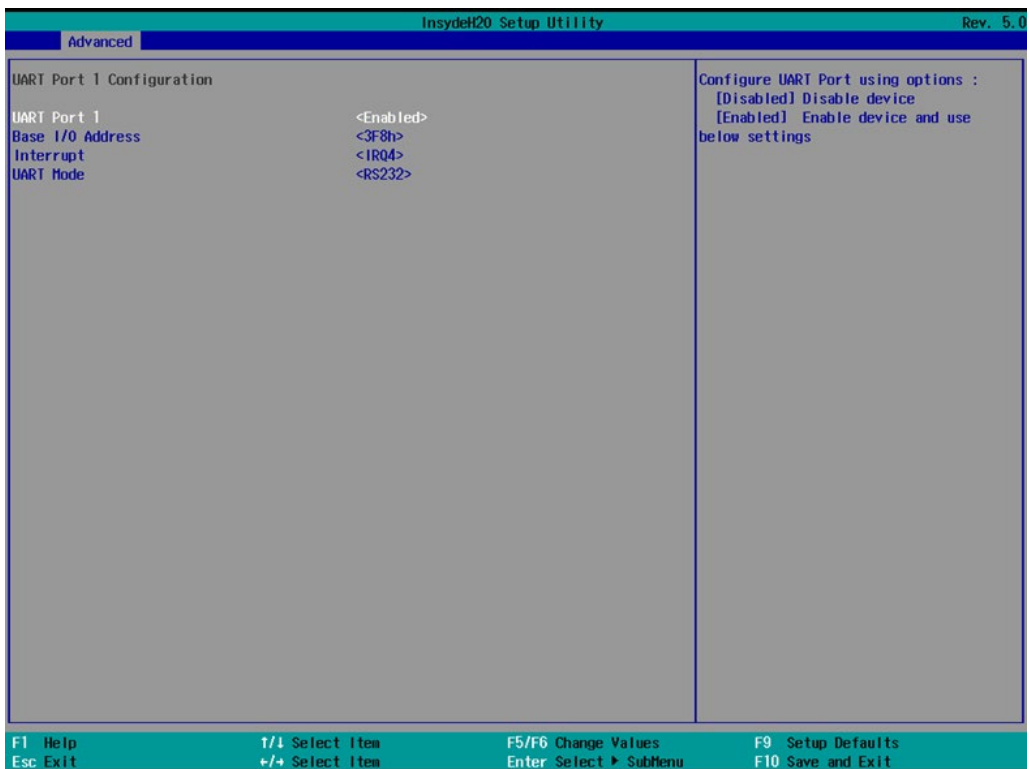
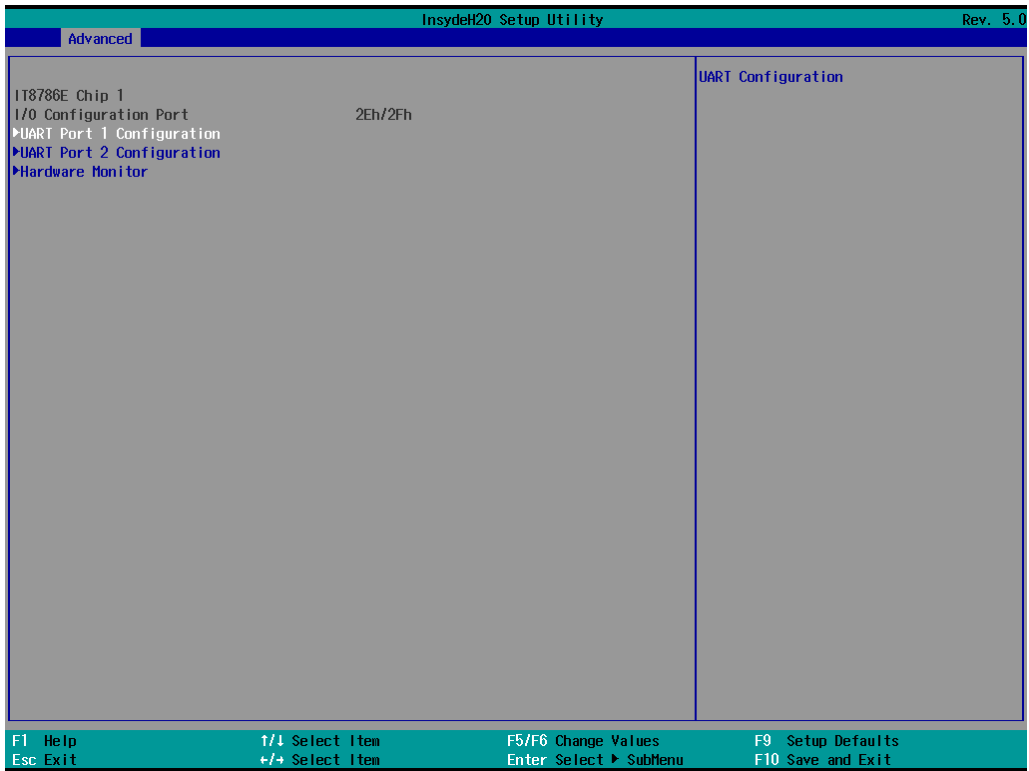

UART Port 1

This function allows users to configure the resources for the UART port 1.

Disable: Disable the UART port 1 connection

Enable: Enable the UART Port 1 connection (default)

UART Port 2

This function allows users to configure the resources for the UART port 2.

Disable: Disable the UART port 2 connection

Enable: Enable the UART Port 2 connection (default)



NOTE

The other UART ports can only be configured by the OS utility.

Hardware Monitor

This section allows you to view stats such as CPU and system temperature, voltage levels, and other chipset information.

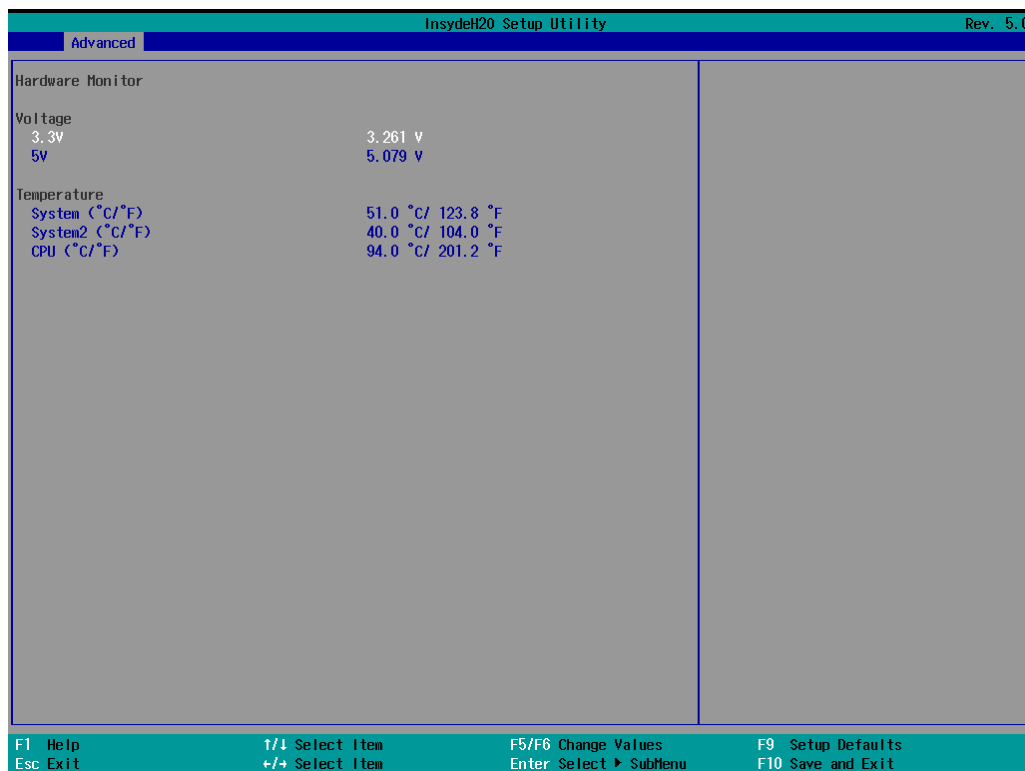

Security Settings

This section allows users to configure security-related settings with a supervisor password.

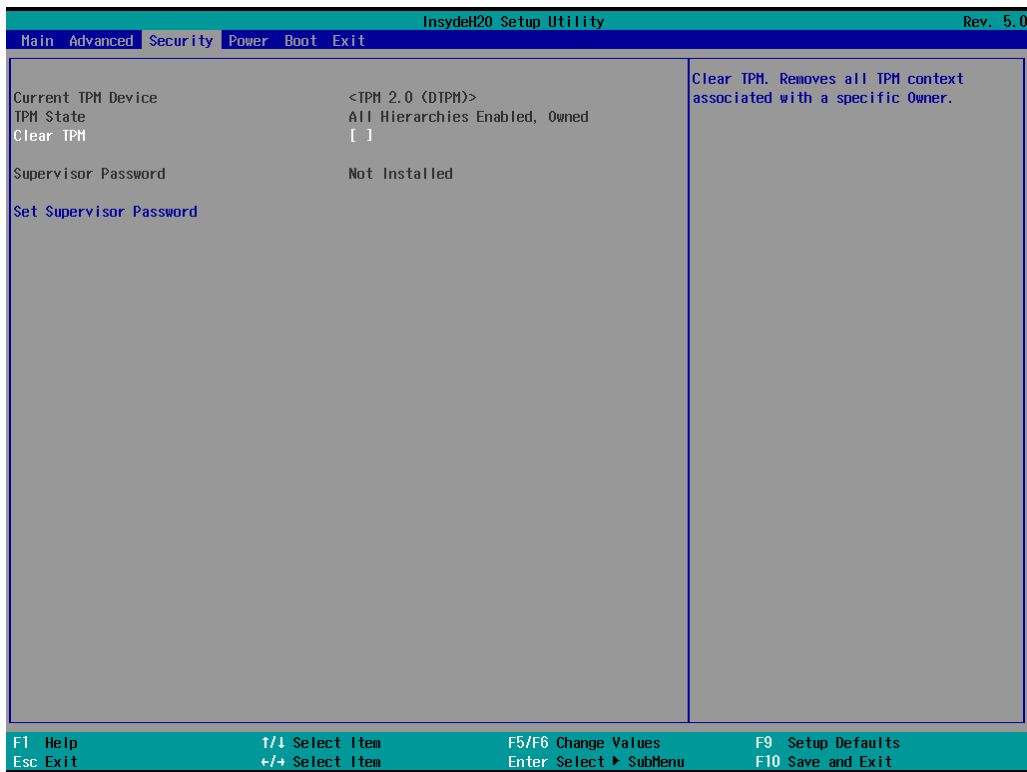

Current TPM Device

This item shows if the system has TPM device and its type.

TPM State

This item allows you view the status of current TPM settings.

Clear TPM

This item allows users to remove all TPM context associated with a specific owner.

Set Supervisor Password

This item allows you to set the supervisor password. Select the **Set Supervisor Password** option and enter the password and confirm the password again.

To delete the password, select the **Set Supervisor Password** option and enter the old password; leave the new password fields blank, and then press enter.

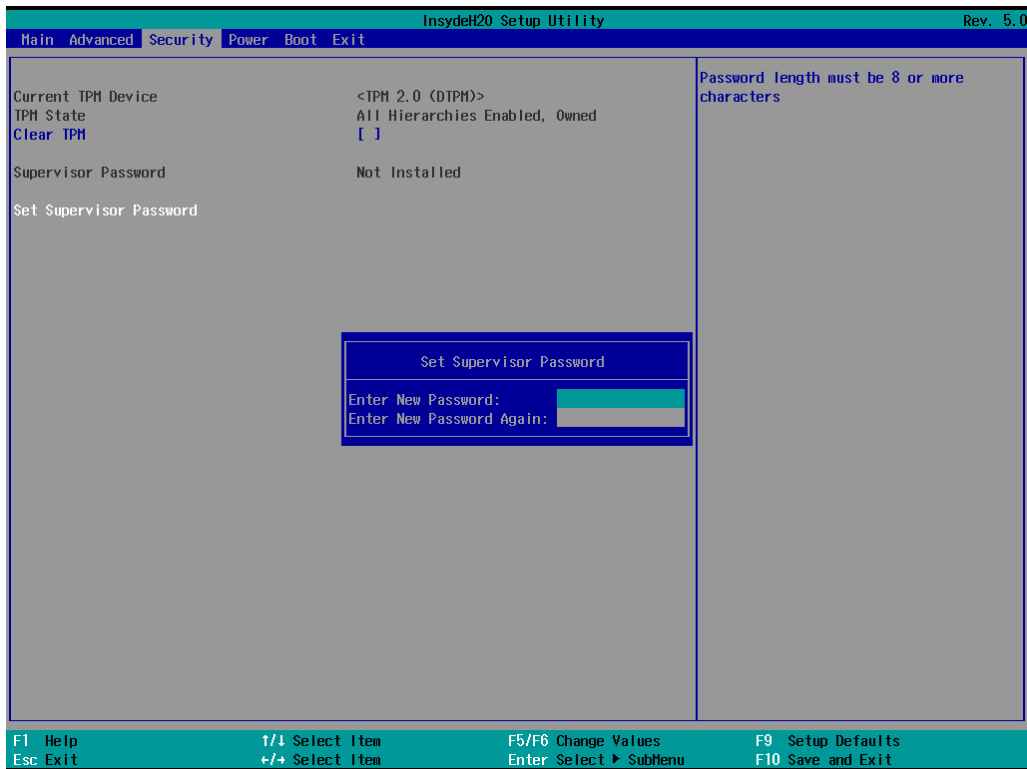

After setting the supervisor password, you can choose when the input password screen should be displayed.

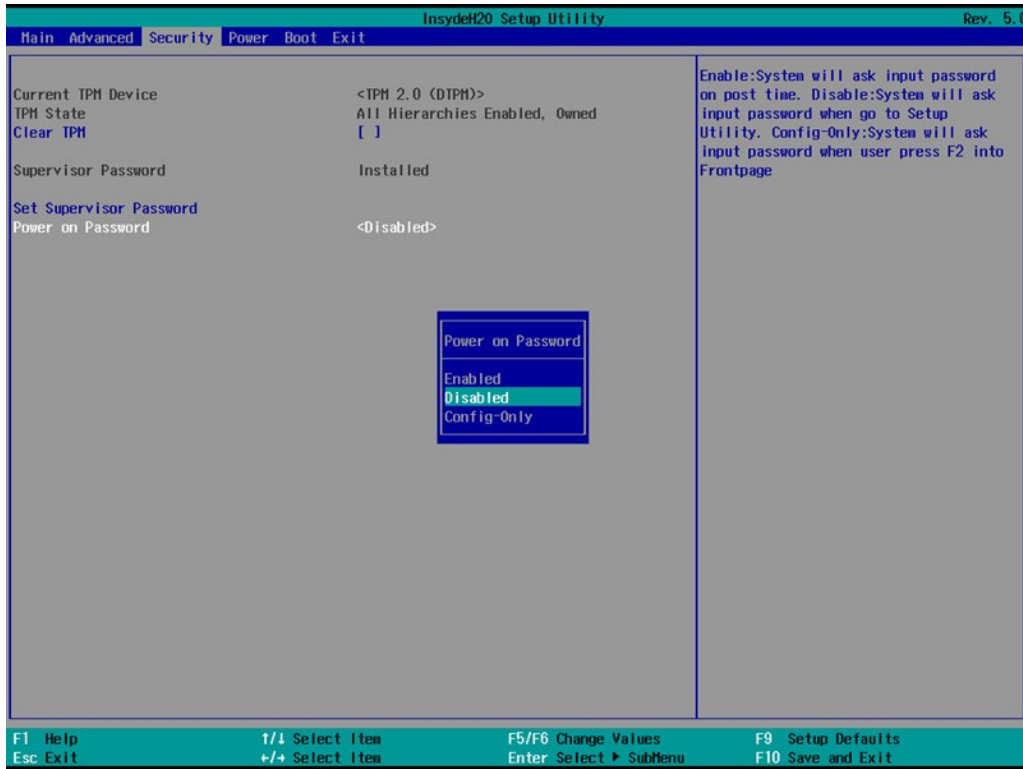

Enable: System will ask for the password on post time

Disable: System will ask for the password to go to the setup utility

Config-Only: System will only ask for the password when you select the config (F2) option

Power Settings

This section allows users to configure power settings.

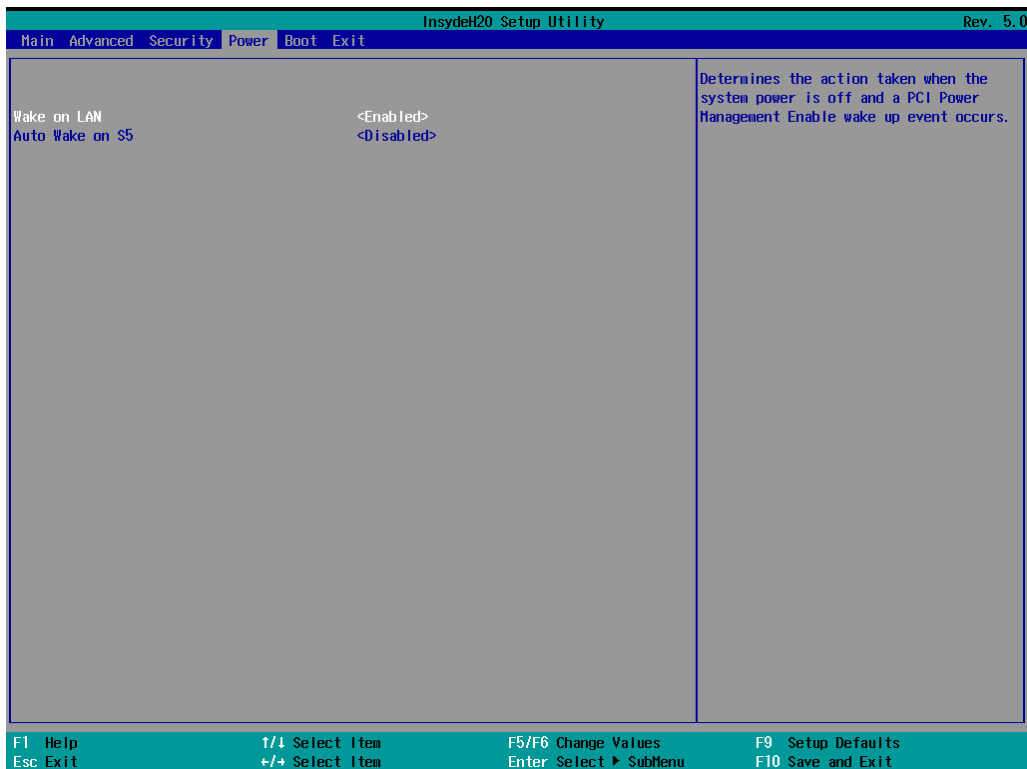

Wake on LAN

This feature is used to wake the system using a LAN device from a remote host.
Options: Enabled (default), Disabled

Auto Wake on S5

This item allows you to configure the computer to wake from S5 status. S5 stands for Soft Off, where the PSU remains engaged but power to all other parts of the system is cut. Auto-wake on S5 schedules a soft-reboot at certain periodic times that may be specified in the BIOS.

Options: Disabled (default); By Every Day (user specifies a regular daily time when the computer will power up); By Day of Month (user specifies a regular day each month when the computer will power up)

Boot Settings

This section allows users to configure boot settings.

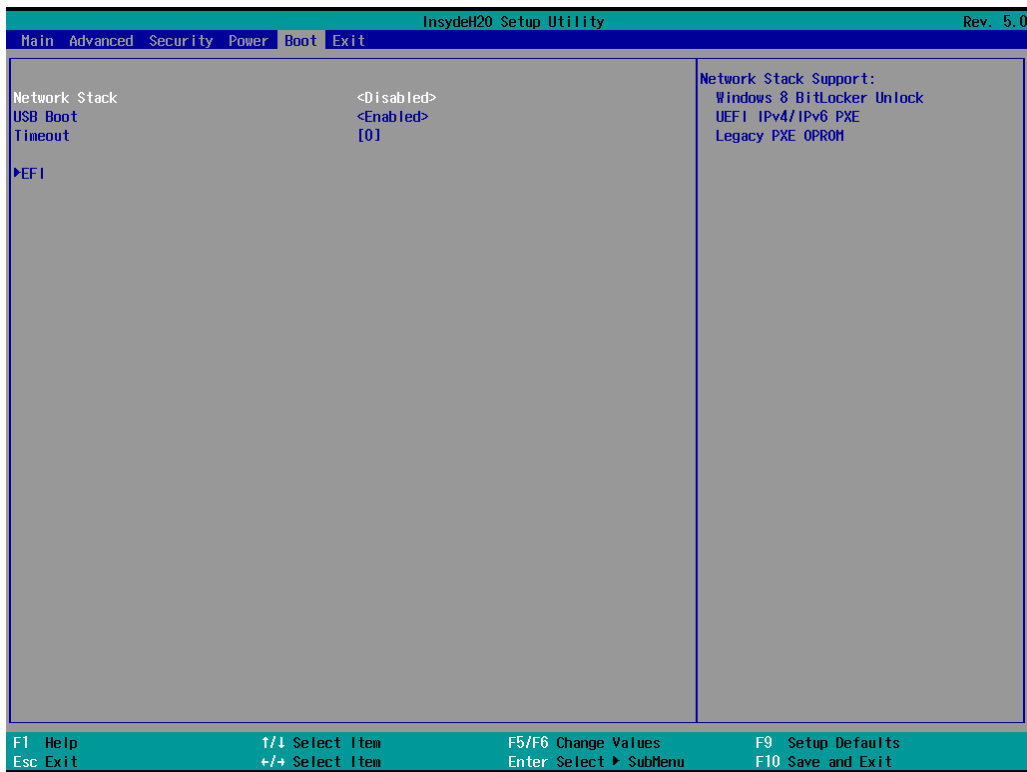

NOTE

If you do not add any storage, you will not see the EFI option.

Network Stack

It deploys an Internet Protocol (IP) stack. The IP stack provides an application library to open/close connections to remote devices and send/receive data between the remote devices.

Options: Disabled (default), Enabled

PXE Boot capability

PXE booting is for booting a system over a network. You can start PXE over IPv4 or IPv6 using this item. Options: Disabled (default), UEFI: IPv4, UEFI: IPv6, UEFI: IPv4/IPv6



NOTE

This item is shown only when you have enabled the Network Stack.

USB Boot

Set booting to USB boot devices capability. Options: Enabled (Default), Disabled

Timeout

This item allows users to set the number of seconds that the firmware will wait before booting from the default boot selection.

EFI

This item allows users to select the boot order. Use F5 (move down) or F6 (move up) to change the value.

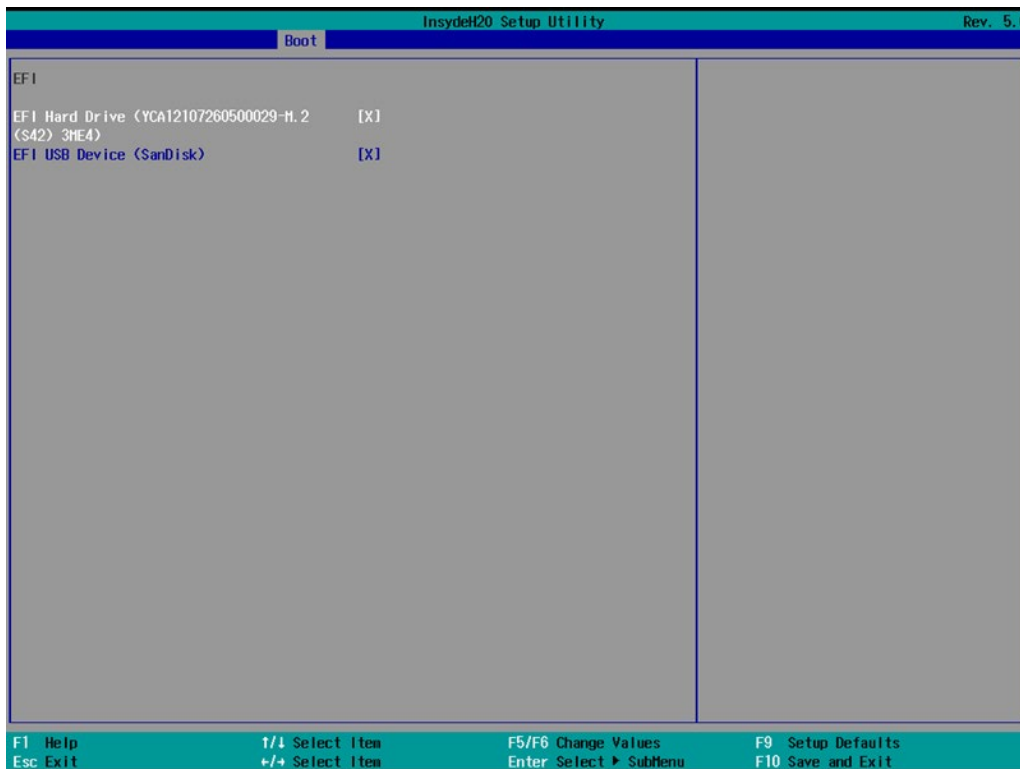

Exit Settings

The section allows users to exit the BIOS environment.

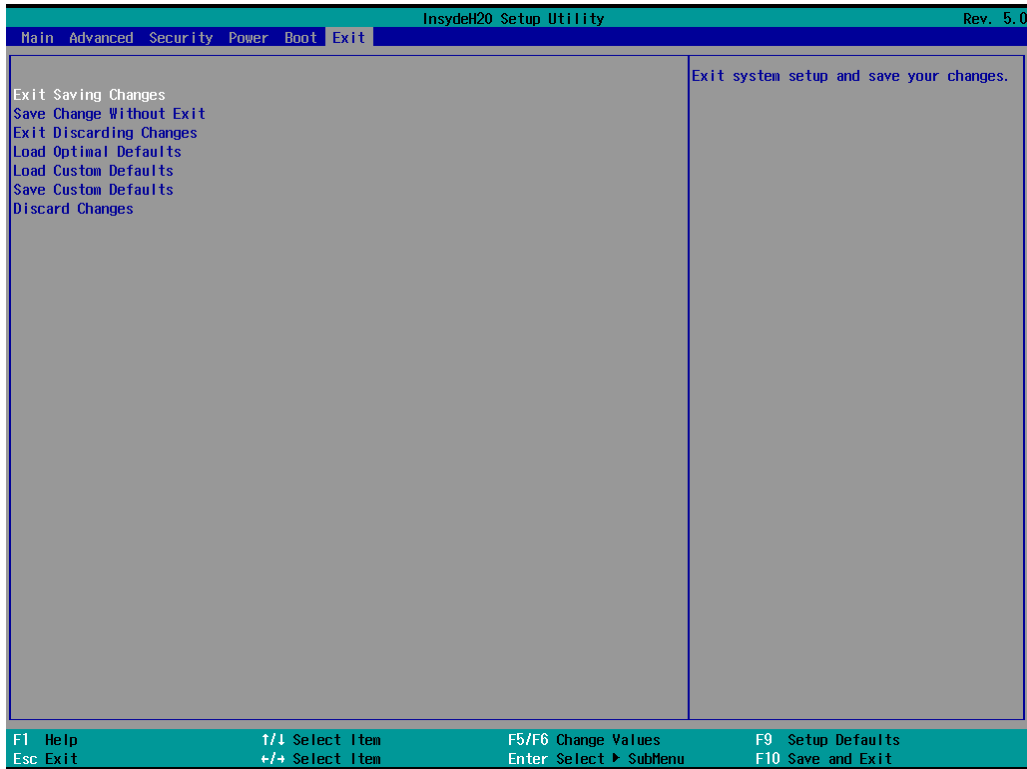

Exit Saving Changes

This item allows you to exit the BIOS environment and save the values you have just configured.

Options: Yes (default), No

Save Change Without Exit

This item allows you to save changes without exiting the BIOS environment.

Options: Yes (default), No

Exit Discarding Changes

This item allows you to exit without saving any changes that might have been made to the BIOS.

Options: Yes (default), No

Load Optimal Defaults

This item allows you to revert to the factory default BIOS values.

Options: Yes (default), No

Load Custom Defaults

This item allows you to load custom default values for the BIOS settings.

Options: Yes (default), No

Save Custom Defaults

This item allows you to save the current BIOS values as a "custom default" that may be reverted to at any time by the load custom defaults selection.

Options: Yes (default), No

Discard Changes

This item allows you to discard all settings you have just configured.

Options: Yes (default), No

Enabling AMT



NOTE

The AMT function is NOT supported in models with Intel® Celeron® and Intel® Core™ i3 processors.

To enter the BIOS setup utility, press the "F2" key while the system is booting up. The main **BIOS Setup** screen will appear. Five options will be available:

1. Select **Intel® Management Engine BIOS Extension** to enter the **AMT** configuration.

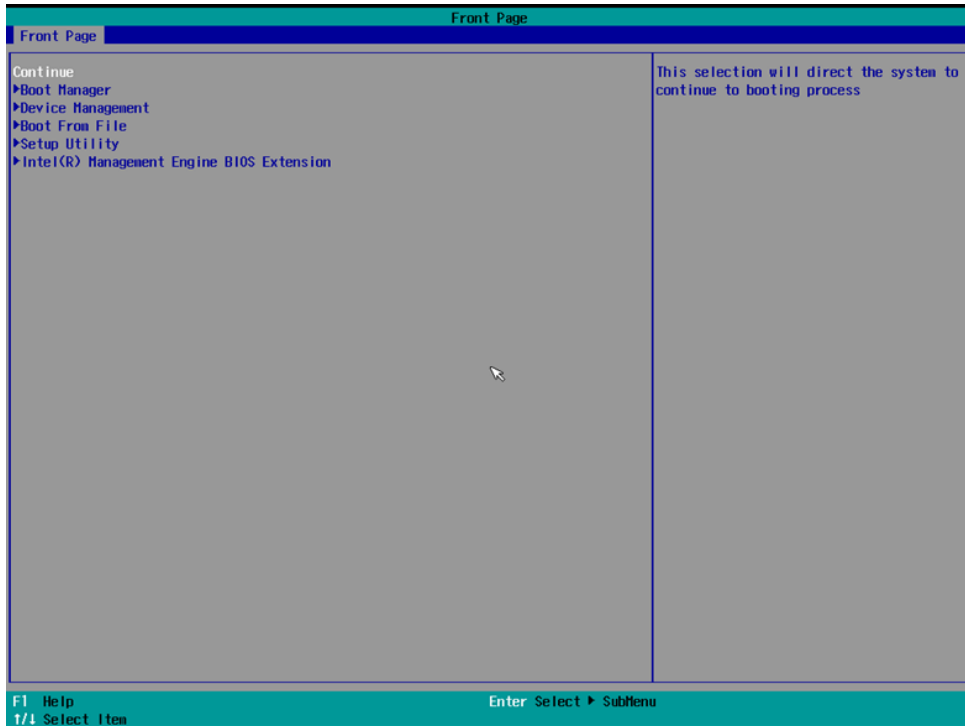

2. Press **<Enter>** to start the login procedure.

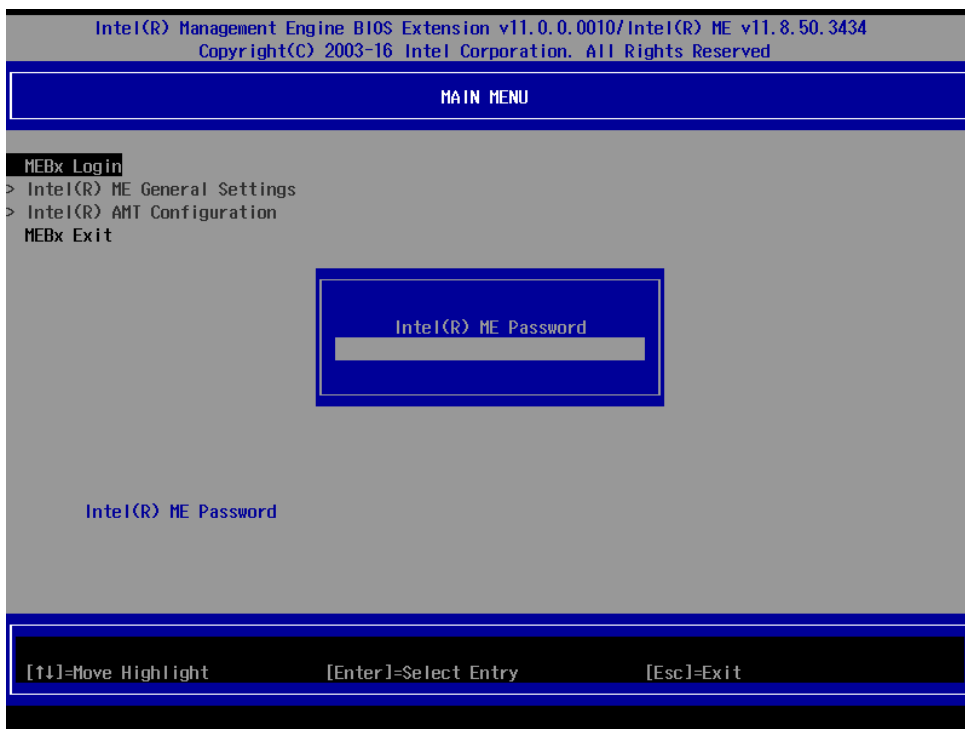

3. Type the default password: **admin**

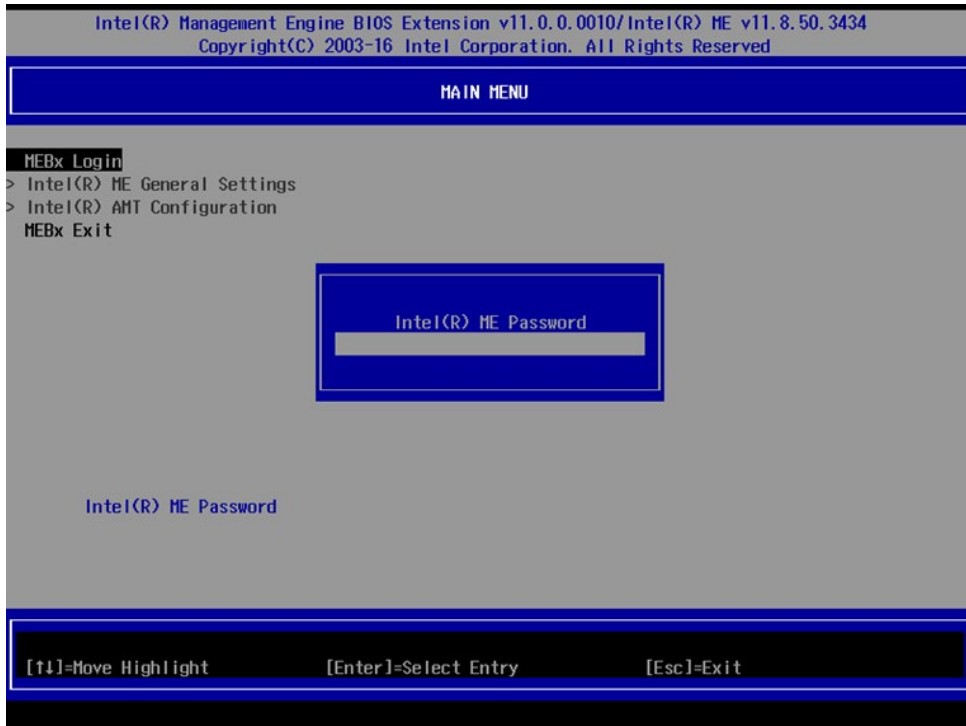

4. Type the new password. It must include both upper-case and lower-case characters, numbers, and special symbols. E.g., **Admin'12**.

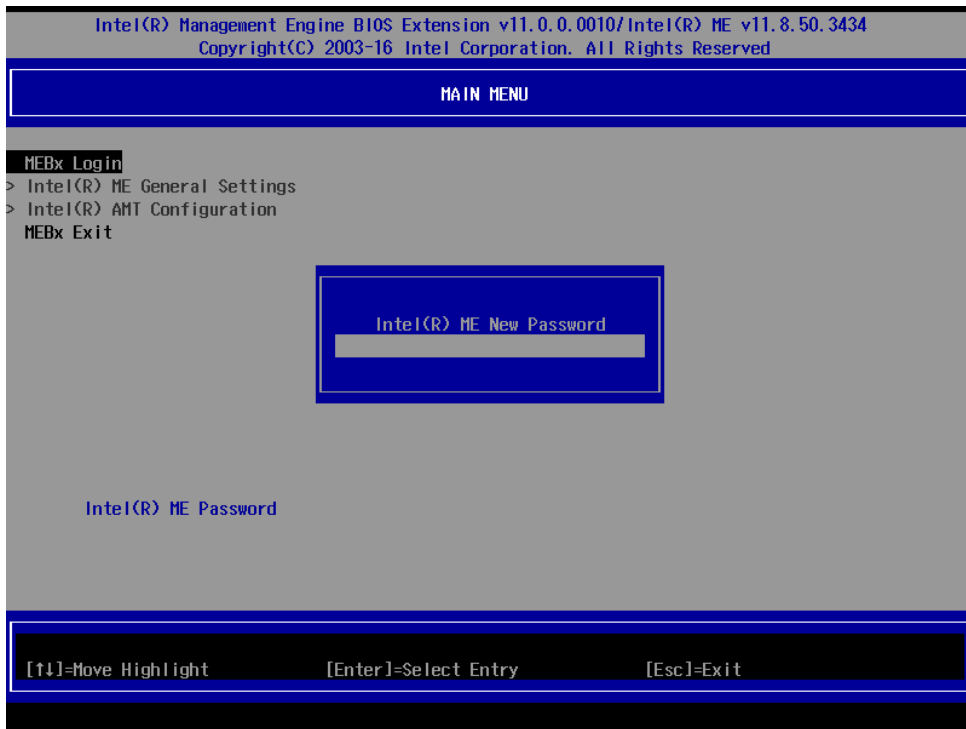

5. Select **Intel® AMT Configuration** to enable remote access without a local user present for consent, select **User Consent**, and then select **User Opt-in** and change the value to **None**.

6. Set static IP or DHCP by request.

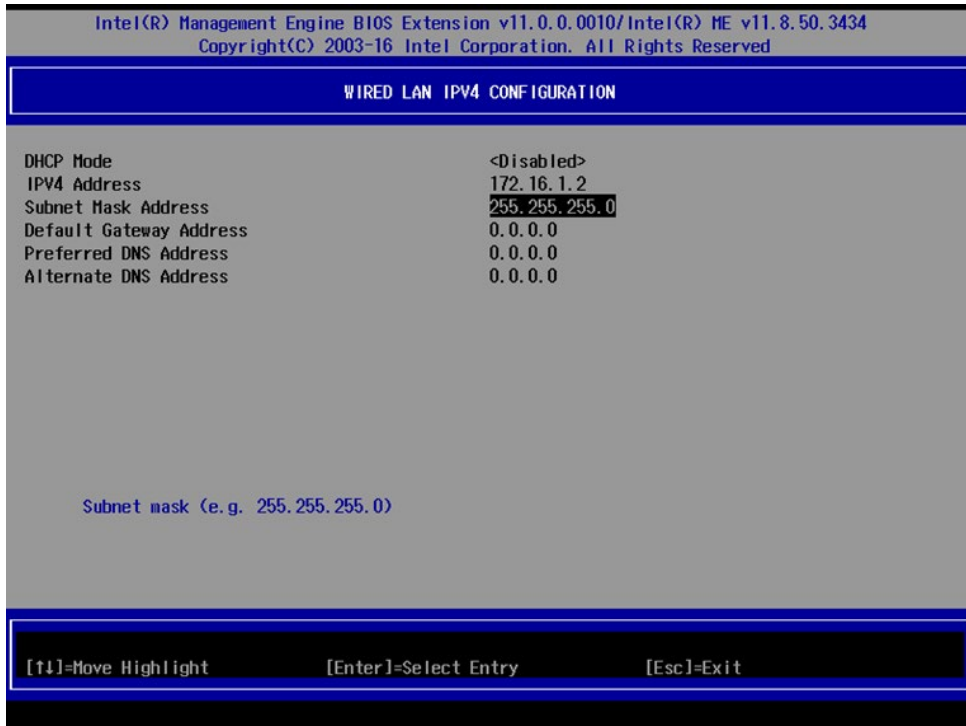

7. Set **Activate Network Access** to enable remote access capability.

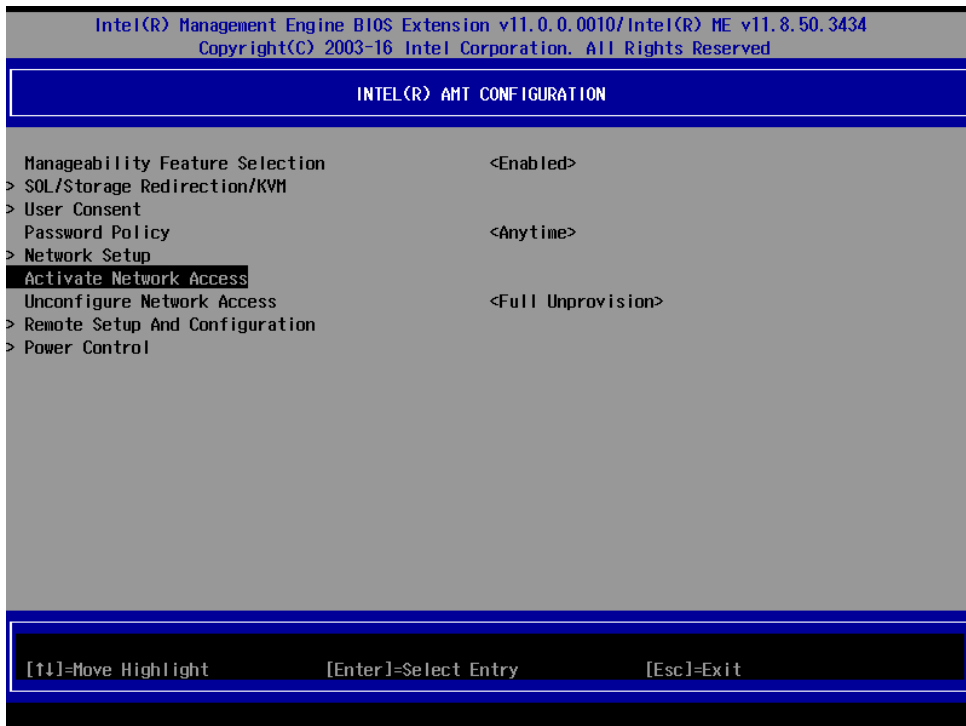

Using AMT

You can use any AMT tool available to run the remote management function using a web browser.

1. Type the IP address of your computer as configured in the AMT configuration settings with port 16992. The AMT logon screen will appear.



2. Click Log On and type the username (admin) and password.

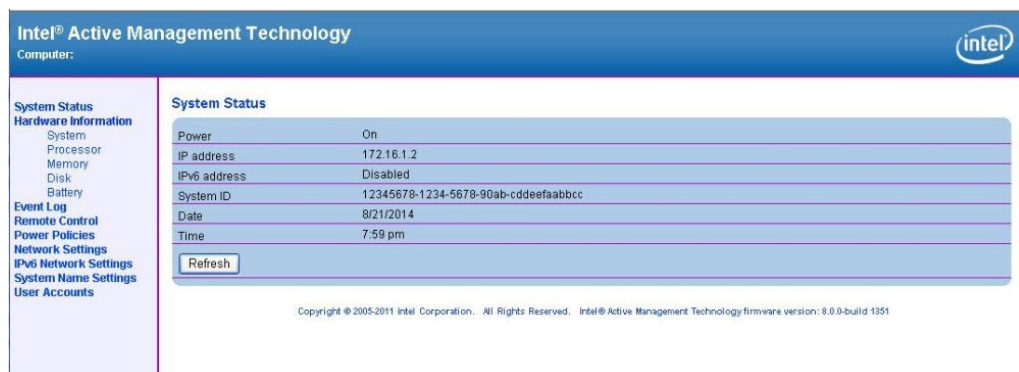

NOTE

The AMT port is LAN1.



NOTE

For details, refer to the Intel AMT Implementation and Reference Guide at:

https://software.intel.com/sites/manageability/AMT_Implementation_and_Reference_Guide/default.htm?url=WordDocuments%2Faccessingintelamtviathewebuiinterface.htm.

Administering Secure Boot

Press F2 to go to the Administer Secure Boot.



Secure Boot helps computers resist attacks and infection from malware. The feature defines an interface between the operating system and BIOS. It detects tampering with boot loaders, key operation system files, and unauthorized option ROMs by validating their digital signatures.

Enabling UEFI Secure Boot

Set as "enabled" in "Restore Secure Boot to Factory Settings" under Administer Secure Boot menu. Press F10 as save and exist.

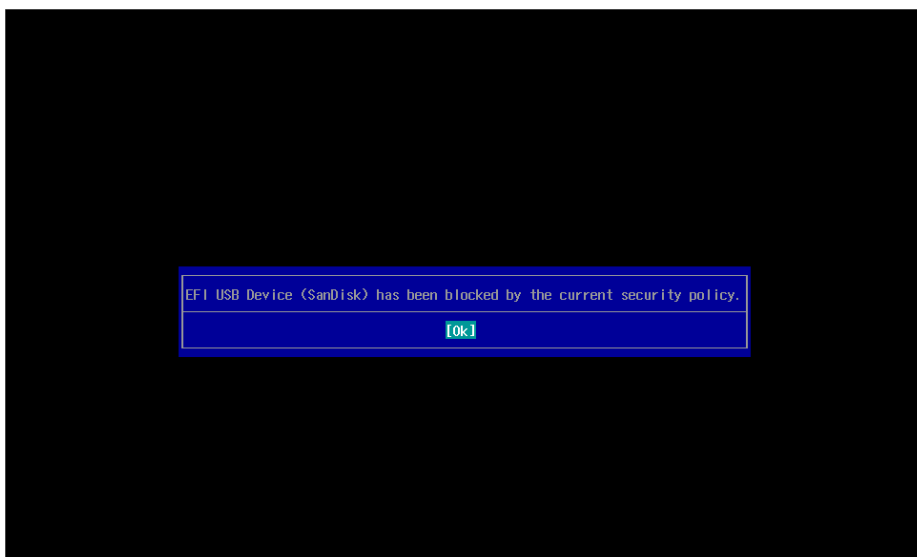

Moxa has included the Microsoft key in the BIOS by default. If you cannot boot up the computer using a non-Windows OS, use the following examples.

Enroll EFI Image

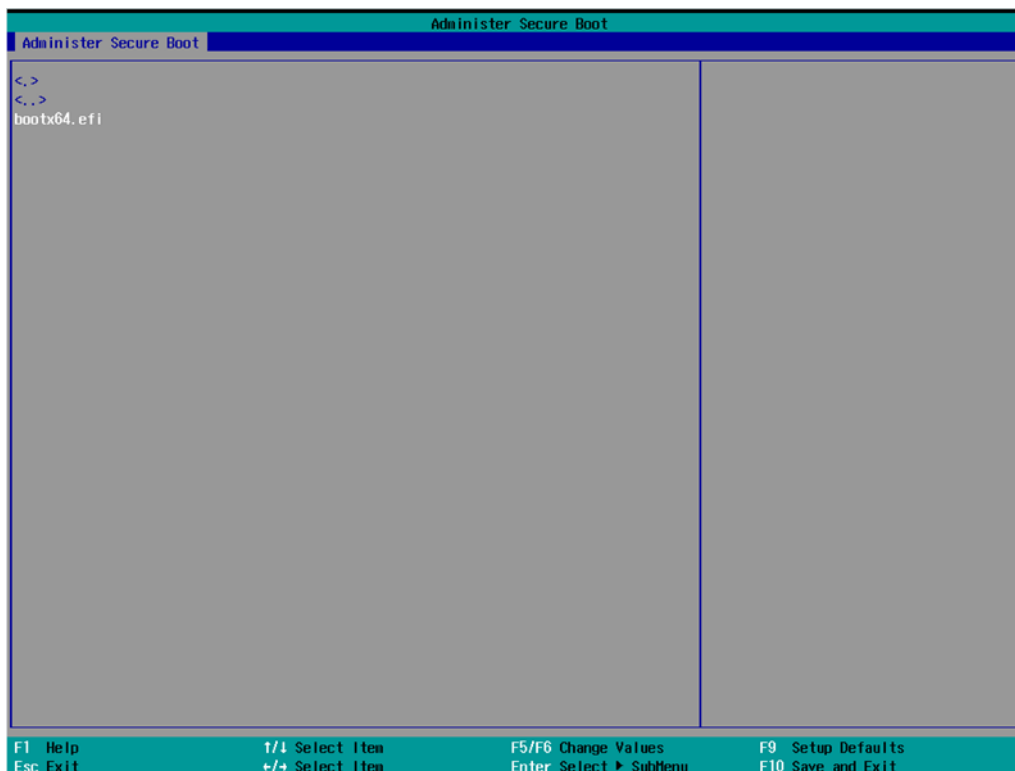
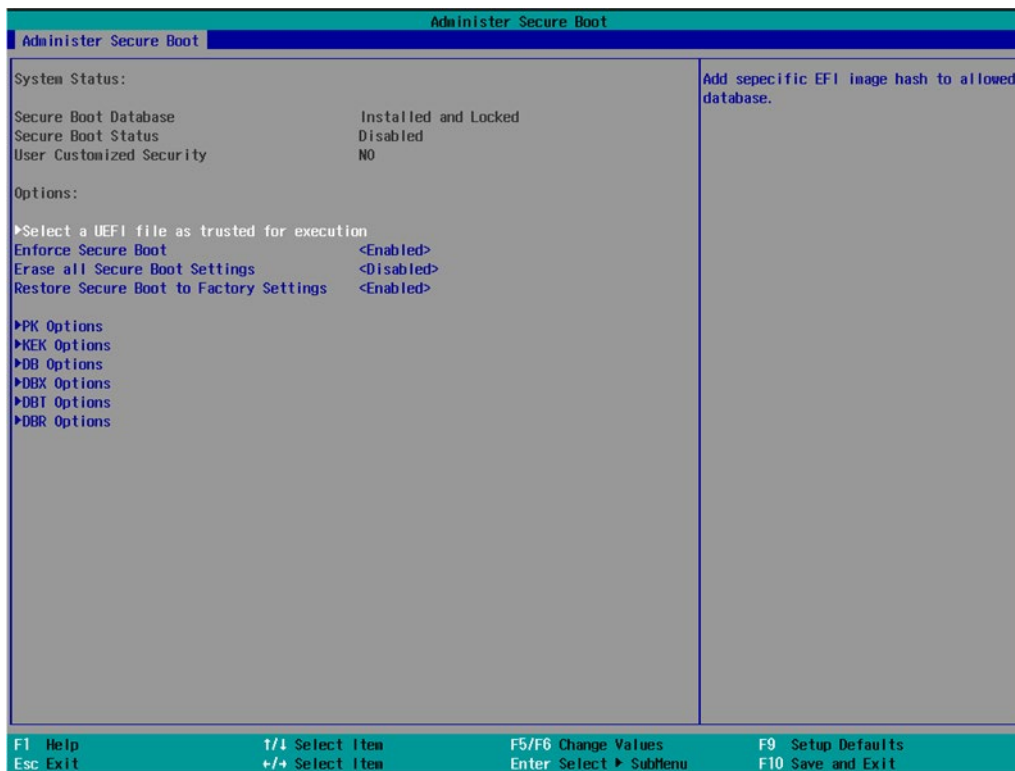

1. Enter **Administer Secure Boot** and select the option **Select a UEFI file as trusted for execution**.
2. Enter the loader name followed by the UEFI standard \EFI\BOOT\BOOT{machine type short-name}.E.g., efi\boot\BootX64.efi, Debian (EFI\debian\grubx64.efi), Suse (EFI\opensuse\grubx64.efi).

Enroll Customer Key

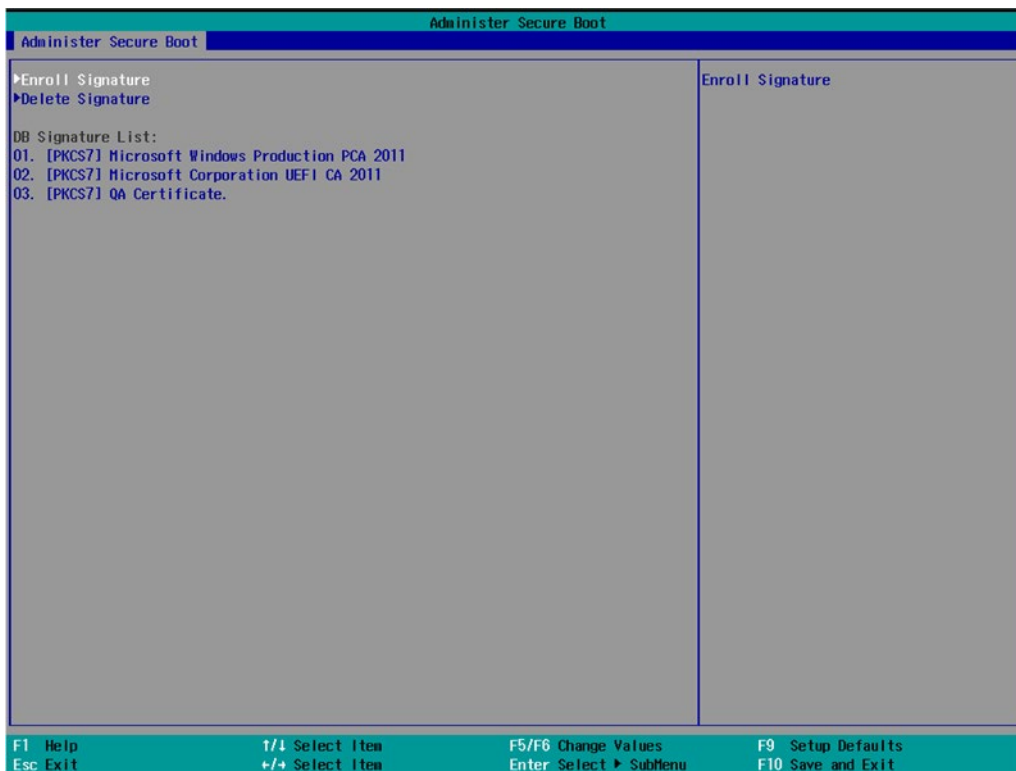
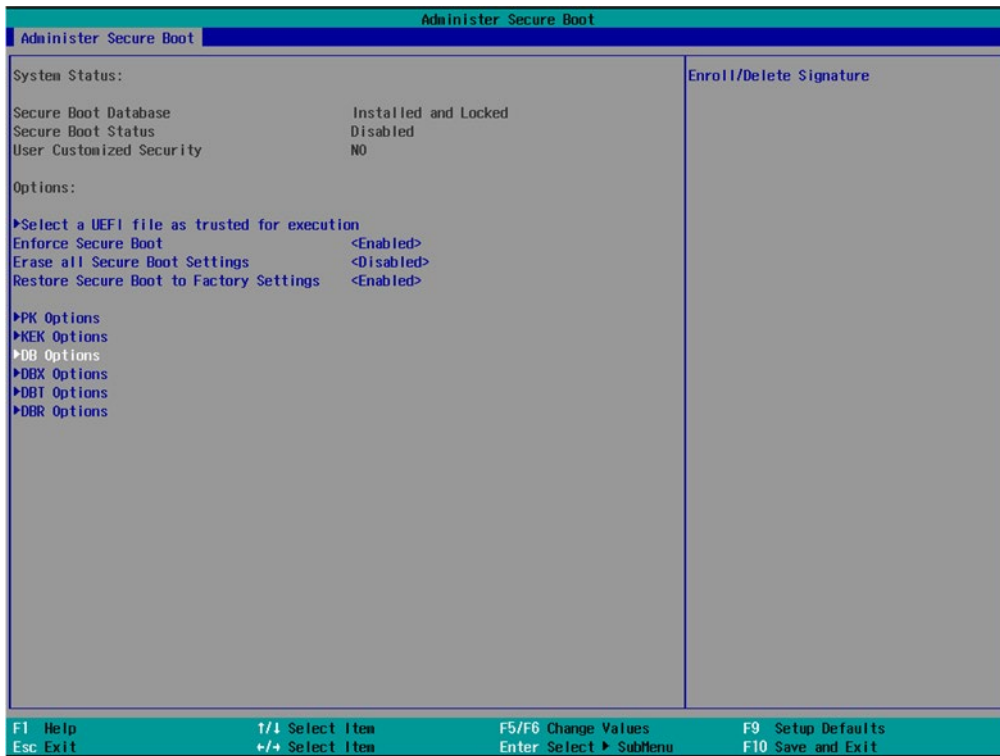

Enter "DB OPTION" and enroll your key. Please make sure your key is CRT format and uses RSA 2048 or better.

Upgrading the BIOS

This section describes how to upgrade the BIOS on your computer.



NOTE

It is possible to permanently damage the computer when upgrading the BIOS. We strongly recommend that you contact Moxa's technical support staff for assistance to obtain all the necessary tools and the most current advice before attempting to upgrade the BIOS on any Moxa device.

Step 1: Create a Bootable USB Disk

Before upgrading the BIOS, you must create a bootable USB drive as a system boot device for use in the future.

1. Insert a USB disk in the computer's USB drive.
2. Search for "format" and select **Create and format hard disk partitions**.

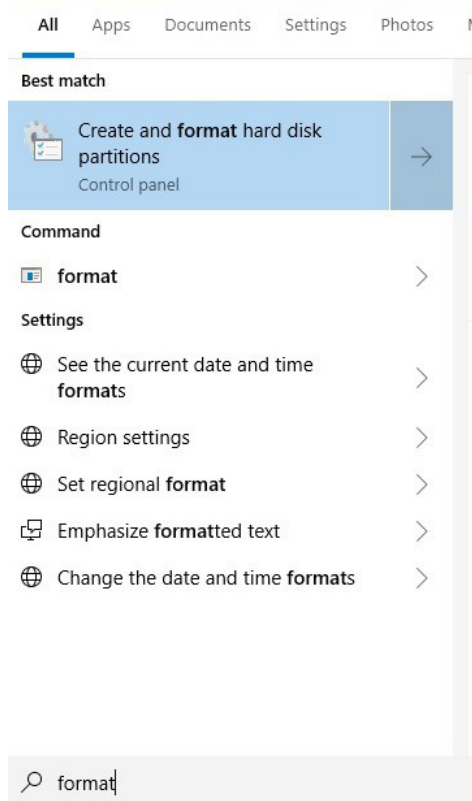

3. Right-click on the USB disk item and select **Format**.

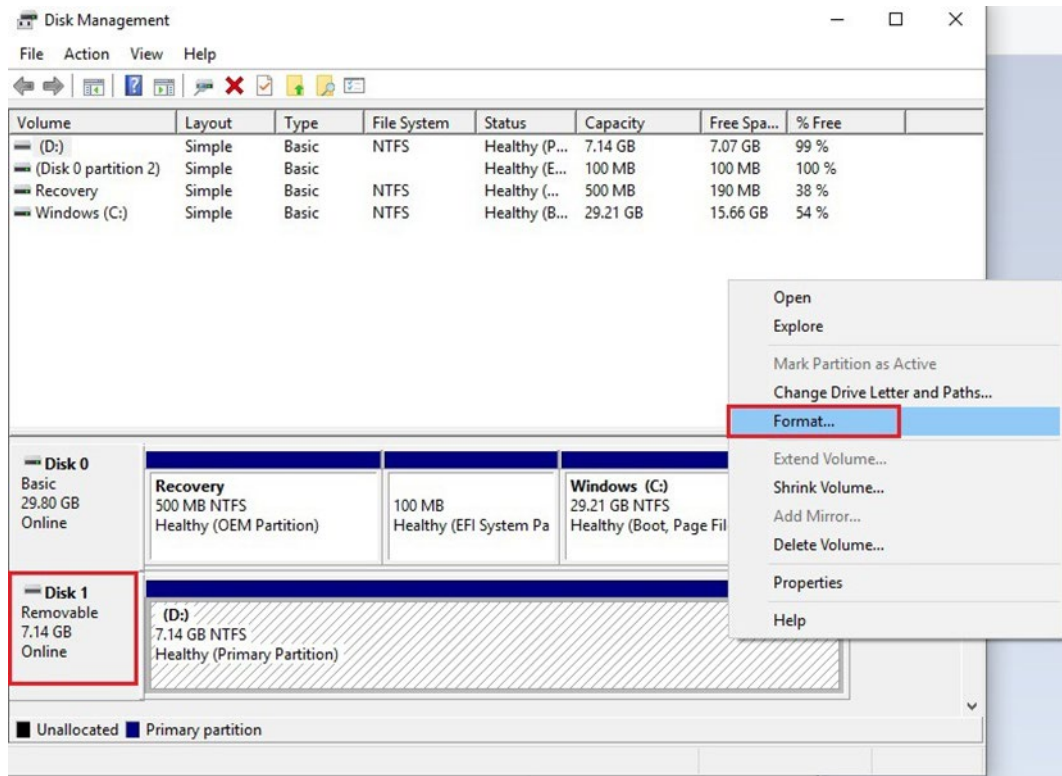

4. Select **FAT32** and click **OK** to start formatting the disk.

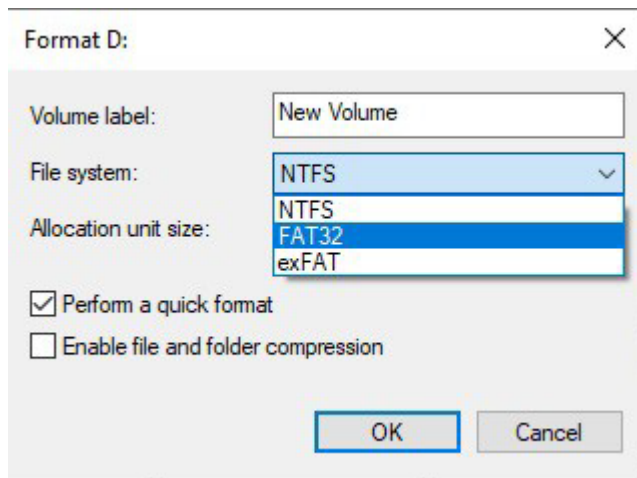

Step 2: Prepare the Upgrade File

You must use the BIOS upgrade installation file to upgrade the BIOS. Contact Moxa's technical department for assistance. The BIOS upgrade file includes an **efi** folder and an **xxxx.efi** file. Copy the **efi** folder and **xxxx.efi** file to the bootable USB disk.

Step 3: Run the Upgrade Program on Your Computer

1. Reboot the computer with the boot disk and press F2 to go to the Boot Manager.
If the BIOS cannot recognize the USB drive as the boot-up device, the USB drive might not have a partition table. Use the Windows command line tool **diskpart** to rebuild the partition table.
2. Select the USB Disk.

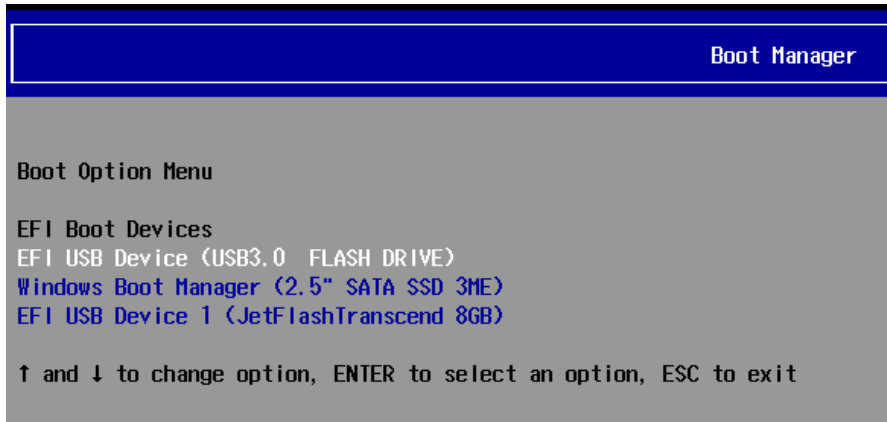

The screen will switch to the SHELL environment.

3. Type **fs0:**, go to the directory where the upgrade file is located, and type **xxxxxx.efi** (the file name is based on the upgrade file from Moxa).

```
Device mapping table
fs0      :Removable HardDisk - Alias hd24s0b blk0
         PciRoot(0x0)/Pci(0x14, 0x0)/USB(0x12, 0x0)/HD(1, MBR, 0x00DD3D80, 0x3F, 0xEB5FC1)
blk0     :Removable HardDisk - Alias hd24s0b fs0
         PciRoot(0x0)/Pci(0x14, 0x0)/USB(0x12, 0x0)/HD(1, MBR, 0x00DD3D80, 0x3F, 0xEB5FC1)
blk1     :Removable BlockDevice - Alias (null)
         PciRoot(0x0)/Pci(0x14, 0x0)/USB(0x12, 0x0)
hd24s0b  :Removable HardDisk - Alias fs0 blk0
         PciRoot(0x0)/Pci(0x14, 0x0)/USB(0x12, 0x0)/HD(1, MBR, 0x00DD3D80, 0x3F, 0xEB5FC1)

Shell> fs0:
fs0:\> xxxxxxx.efi
```

4. Wait until the upgrade procedure is completed.



ATTENTION

Do NOT switch off the power supply during the BIOS upgrade, since doing so may cause the system to crash.

```

Insyde H20FFT (Flash Firmware Tool) Version (SEG) 200.00.00.13
Copyright (C) 2020 Insyde Software Corp. All Rights Reserved.

Loading New BIOS Image File: Done

Current BIOS Model Name:
New BIOS Model Name:
Current BIOS Version: V1.0.0S12
New BIOS Version: V1.0.0S12

Common Region:00 StartAddr:0xFE000000 EndAddr:0xFE000FFF
Common Region:01 StartAddr:0xFF400000 EndAddr:0xFFFFFFFF
Updating Block at FE21D000h
0%      25%      50%      75%      100%
[Progress bar] 6%

```

When the upgrade is finished, the computer will automatically reboot. You can check the BIOS version on the Main page to confirm the upgrade.

```

Main Advanced Security Power Boot Exit
-----
Project Name
BIOS Version                                V1.0.0S12

```

If the system has more than one boot device, you will see more than one fsx (x represents the number).

```

EFI Shell version 2.50 [22281.41491]
Current running mode 1.1.2
Device mapping table
fs0 :HardDisk - Alias hd33e0a2 blk0
      PciRoot(0x0)/Pci(0x17,0x0)/Sata(0x4,0x0,0x0)/HD(2,GPT,0AC3B829-99B0-4FDE-844D-8A10C1D55C6C,0xFA000,0x32000)
fs1 :Removable HardDisk - Alias hd25r0b blk1
      PciRoot(0x0)/Pci(0x14,0x0)/USB(0x11,0x0)/HD(1,HBR,0x00DD3D80,0x3F,0xEB5FC1)
fs2 :Removable BlockDevice - Alias f25s0 blk2
      PciRoot(0x0)/Pci(0x14,0x0)/USB(0x12,0x0)
blk0 :HardDisk - Alias hd33e0a2 fs0
      PciRoot(0x0)/Pci(0x17,0x0)/Sata(0x4,0x0,0x0)/HD(2,GPT,0AC3B829-99B0-4FDE-844D-8A10C1D55C6C,0xFA000,0x32000)
blk1 :Removable HardDisk - Alias hd25r0b fs1
      PciRoot(0x0)/Pci(0x14,0x0)/USB(0x11,0x0)/HD(1,HBR,0x00DD3D80,0x3F,0xEB5FC1)
blk2 :Removable BlockDevice - Alias f25s0 fs2
      PciRoot(0x0)/Pci(0x14,0x0)/USB(0x12,0x0)
blk3 :HardDisk - Alias (null)
      PciRoot(0x0)/Pci(0x17,0x0)/Sata(0x4,0x0,0x0)/HD(1,GPT,5796BAEF-EC3F-447F-B4F1-21EB08DC5D57,0x800,0xF9800)
blk4 :HardDisk - Alias (null)
      PciRoot(0x0)/Pci(0x17,0x0)/Sata(0x4,0x0,0x0)/HD(3,GPT,7C8FF3C6-53E8-4CF9-8141-65DF7EF04399,0x12C000,0x8000)
blk5 :HardDisk - Alias (null)
      PciRoot(0x0)/Pci(0x17,0x0)/Sata(0x4,0x0,0x0)/HD(4,GPT,1AABAECE-BE17-4C27-AF60-E6C69977AC02,0x134000,0x3A6E800)
blk6 :BlockDevice - Alias (null)
      PciRoot(0x0)/Pci(0x17,0x0)/Sata(0x4,0x0,0x0)
blk7 :Removable BlockDevice - Alias (null)
      PciRoot(0x0)/Pci(0x14,0x0)/USB(0x11,0x0)

```

5. Go to each fsx (x stands for the number) and type ls to view the content of the boot device. If you find an upgrade file, run it.

```

fs0:\> fs1:
fs1:\> ls
Directory of: fs1:\
06/27/19 11:43a <DIR>          16,384 efi
06/13/19 11:10a          17,974,704 820C100S16 efi
1 File(s) 17,974,704 bytes
1 Dir(s)

```

A. Regulatory Approval Statement



This device complies with part 15 of the FCC Rules. Operation is subject to the following two conditions: (1) This device may not cause harmful interference, and (2) this device must accept any interference received, including interference that may cause undesired operation.

Class A: FCC Warning! This equipment has been tested and found to comply with the limits for a Class A digital device, pursuant to part 15 of the FCC Rules. These limits are designed to provide reasonable protection against harmful interference when the equipment is operated in a commercial environment. This equipment generates, uses, and can radiate radio frequency energy and, if not installed and used in accordance with the instruction manual, may cause harmful interference to radio communications. Operation of this equipment in a residential area is likely to cause harmful interference in which case the user will be required to correct the interference at his or her own expense.



European Community

Warning:

This is a class A product. If used in a domestic environment, this product may cause undesirable radio interference, in which case the user may be required to take adequate measures to prevent the interference from affecting nearby devices.