

User Manual

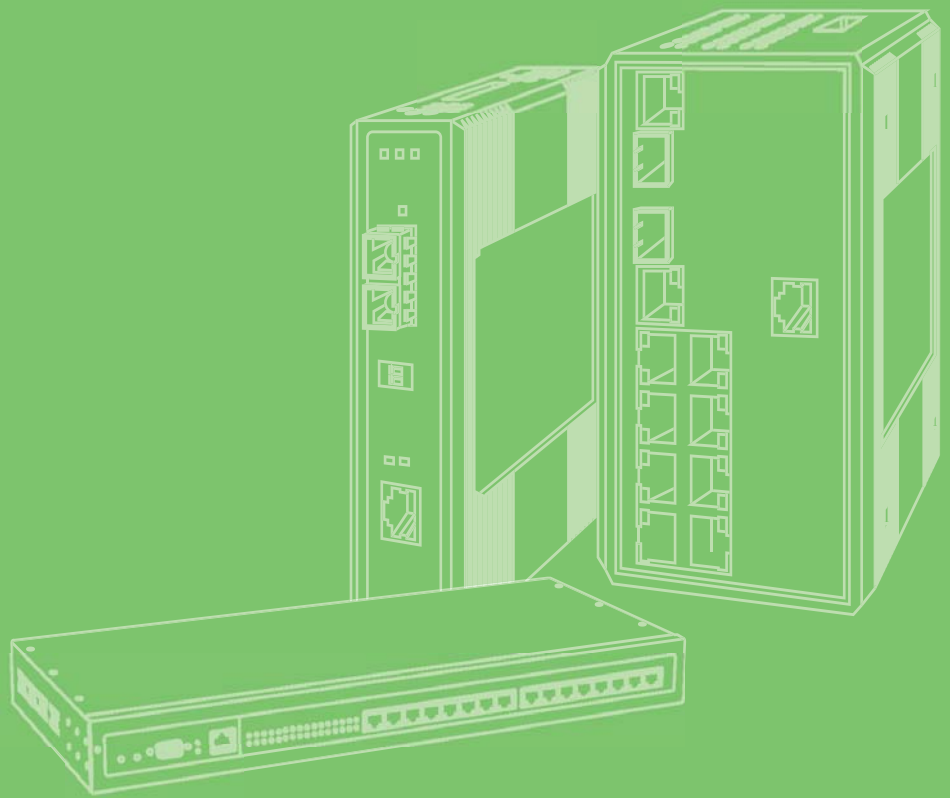

EKI-1751I

Industrial Ethernet Extender

ADVANTECH

Enabling an Intelligent Planet

Copyright

The documentation and the software included with this product are copyrighted 2018 by Advantech Co., Ltd. All rights are reserved. Advantech Co., Ltd. reserves the right to make improvements in the products described in this manual at any time without notice. No part of this manual may be reproduced, copied, translated or transmitted in any form or by any means without the prior written permission of Advantech Co., Ltd. Information provided in this manual is intended to be accurate and reliable. However, Advantech Co., Ltd. assumes no responsibility for its use, nor for any infringements of the rights of third parties, which may result from its use.

Acknowledgments

Intel and Pentium are trademarks of Intel Corporation.

Microsoft Windows and MS-DOS are registered trademarks of Microsoft Corp.

All other product names or trademarks are properties of their respective owners.

Product Warranty (5 years)

Advantech warrants to you, the original purchaser, that each of its products will be free from defects in materials and workmanship for five years from the date of purchase.

This warranty does not apply to any products which have been repaired or altered by persons other than repair personnel authorized by Advantech, or which have been subject to misuse, abuse, accident or improper installation. Advantech assumes no liability under the terms of this warranty as a consequence of such events.

Because of Advantech's high quality-control standards and rigorous testing, most of our customers never need to use our repair service. If an Advantech product is defective, it will be repaired or replaced at no charge during the warranty period. For out-of-warranty repairs, you will be billed according to the cost of replacement materials, service time and freight. Please consult your dealer for more details.

If you think you have a defective product, follow these steps:

1. Collect all the information about the problem encountered. (For example, CPU speed, Advantech products used, other hardware and software used, etc.) Note anything abnormal and list any on screen messages you get when the problem occurs.
2. Call your dealer and describe the problem. Please have your manual, product, and any helpful information readily available.
3. If your product is diagnosed as defective, obtain an RMA (return merchandise authorization) number from your dealer. This allows us to process your return more quickly.
4. Carefully pack the defective product, a fully-completed Repair and Replacement Order Card and a photocopy proof of purchase date (such as your sales receipt) in a shippable container. A product returned without proof of the purchase date is not eligible for warranty service.
5. Write the RMA number visibly on the outside of the package and ship it prepaid to your dealer.

Declaration of Conformity

CE

This product has passed the CE test for environmental specifications. Test conditions for passing included the equipment being operated within an industrial enclosure. In order to protect the product from being damaged by ESD (Electrostatic Discharge) and EMI leakage, we strongly recommend the use of CE-compliant industrial enclosure products.

FCC Class A

Note: This equipment has been tested and found to comply with the limits for a Class A digital device, pursuant to part 15 of the FCC Rules. These limits are designed to provide reasonable protection against harmful interference when the equipment is operated in a commercial environment. This equipment generates, uses, and can radiate radio frequency energy and, if not installed and used in accordance with the instruction manual, may cause harmful interference to radio communications. Operation of this equipment in a residential area is likely to cause harmful interference in which case the user will be required to correct the interference at his own expense.

Technical Support and Assistance

1. Visit the Advantech web site at www.advantech.com/support where you can find the latest information about the product.
2. Contact your distributor, sales representative, or Advantech's customer service center for technical support if you need additional assistance. Please have the following information ready before you call:
 - Product name and serial number
 - Description of your peripheral attachments
 - Description of your software (operating system, version, application software, etc.)
 - A complete description of the problem
 - The exact wording of any error messages

Warnings, Cautions and Notes

Warning! Warnings indicate conditions, which if not observed, can cause personal injury!



Caution! Cautions are included to help you avoid damaging hardware or losing data. e.g.



There is a danger of a new battery exploding if it is incorrectly installed. Do not attempt to recharge, force open, or heat the battery. Replace the battery only with the same or equivalent type recommended by the manufacturer. Discard used batteries according to the manufacturer's instructions.

Note! Notes provide optional additional information.



Document Feedback

To assist us in making improvements to this manual, we would welcome comments and constructive criticism. Please send all such - in writing to: support@advantech.com

Packing List

Before setting up the system, check that the items listed below are included and in good condition. If any item does not accord with the table, please contact your dealer immediately.

- 1 x Industrial Ethernet Extender
- 1 x DIN-Rail Mounting Bracket and Screws
- 1 x Wall-mounting Bracket

Safety Instructions

- Read these safety instructions carefully.
- Keep this User Manual for later reference.
- Disconnect this equipment from any DC outlet before cleaning. Use a damp cloth. Do not use liquid or spray detergents for cleaning.
- For plug-in equipment, the power outlet socket must be located near the equipment and must be easily accessible.
- Keep this equipment away from humidity.
- Put this equipment on a reliable surface during installation. Dropping it or letting it fall may cause damage.
- The openings on the enclosure are for air convection. Protect the equipment from overheating. **DO NOT COVER THE OPENINGS.**
- Make sure the voltage of the power source is correct before connecting the equipment to the power outlet.
- Position the power cord so that people cannot step on it. Do not place anything over the power cord.
- All cautions and warnings on the equipment should be noted.
- If the equipment is not used for a long time, disconnect it from the power source to avoid damage by transient overvoltage.
- Never pour any liquid into an opening. This may cause fire or electrical shock.
- Never open the equipment. For safety reasons, the equipment should be opened only by qualified service personnel.
- If one of the following situations arises, get the equipment checked by service personnel:
 - The power cord or plug is damaged.
 - Liquid has penetrated into the equipment.
 - The equipment has been exposed to moisture.
 - The equipment does not work well, or you cannot get it to work according to the user's manual.
 - The equipment has been dropped and damaged.
 - The equipment has obvious signs of breakage.
- **DO NOT LEAVE THIS EQUIPMENT IN AN ENVIRONMENT WHERE THE STORAGE TEMPERATURE MAY GO -40°C (-40°F) ~ 75°C (167°F). THIS COULD DAMAGE THE EQUIPMENT. THE EQUIPMENT SHOULD BE IN A CONTROLLED ENVIRONMENT.**
- The sound pressure level at the operator's position according to IEC 704-1:1982 is no more than 70 dB (A).

DISCLAIMER: This set of instructions is given according to IEC 704-1. Advantech disclaims all responsibility for the accuracy of any statements contained herein.

Safety Precaution - Static Electricity

Static electricity can cause bodily harm or damage electronic devices. To avoid damage, keep static-sensitive devices in the static-protective packaging until the installation period. The following guidelines are also recommended:

- Wear a grounded wrist or ankle strap and use gloves to prevent direct contact to the device before servicing the device. Avoid nylon gloves or work clothes, which tend to build up a charge.
- Always disconnect the power from the device before servicing it.
- Before plugging a cable into any port, discharge the voltage stored on the cable by touching the electrical contacts to the ground surface.

Contents

| | | |
|------------------|-----------------------------------------|-----------|
| Chapter 1 | Product Introduction | 1 |
| 1.1 | Description | 2 |
| 1.2 | Features | 2 |
| 1.3 | Specifications | 3 |
| 1.4 | Applications | 4 |
| 1.5 | Reference Performance Data | 4 |
| 1.5.1 | 24AWG Copper Wire | 4 |
| 1.5.2 | Coaxial Cable (RG-58/5C-2V) | 5 |
| Chapter 2 | Hardware Description | 6 |
| 2.1 | Product Overview | 7 |
| 2.1.1 | Ping assignment for M12 Connector | 7 |
| 2.2 | Installing Accessory Kits | 8 |
| Chapter 3 | LED Definitions | 9 |
| 3.1 | LED Indicators | 10 |
| Chapter 4 | Power | 11 |
| Chapter 5 | 3-Position DIP Switch | 13 |
| 5.1 | Band Plan | 14 |
| 5.2 | General Protection | 14 |
| 5.3 | OT (Master) / RT (Remote) | 15 |

List of Figures

| | | |
|------------|-----------------------------------------|----|
| Figure 1.1 | Applications | 4 |
| Figure 2.1 | Product Overview | 7 |
| Figure 2.2 | Ping assignment for M12 Connector | 7 |
| Figure 2.3 | Installing Accessory Kits | 8 |
| Figure 5.1 | 3-Position DIP Switch | 14 |
| Figure 5.2 | PIN 1..... | 14 |
| Figure 5.3 | PIN 2..... | 14 |
| Figure 5.4 | PIN 3..... | 15 |

Chapter 1

Product Introduction

1.1 Description

The EKI-1751I, industrial-grade 2-port 10/100Base-TX RJ-45 Ethernet Extender with an M12 connector, is designed to extend the reach of Ethernet data over existing copper cable beyond the natural limitations of 100m for industrial applications. With an M12 Ethernet connector design, the EKI-1751I is the ideal plug-n-play solution for industrial environments requiring reliable data transmission and secure protection against severe interference .

Utilizing VDSL2 Technology, EKI-1751I extenders offer fast data transmission up to 100 Mbps rate within 300M or 20 Mbps bandwidth for 1.2 Km long range connections. With built-in wide temperature operating range from -40°C (-40°F) to 75°C (167°F) and a rugged IP30 aluminum housing, EKI-1751I solutions are suitable for use in harsh environments. Outstanding resistance to shock and vibration optimize the EKI-1751I for signal integrity to ensure reliable high-speed transmission performance .

To fulfill market demand for extensible architecture, EKI-1751I extenders are equipped with two Ethernet ports and an M12 connector. Supporting multi-mode operations, EKI-1751I offers VDSL2 Band-Plans (Asymmetric or Symmetric), SNR margin (6dB or 9dB) and Master or Remote mode through a simple to use DIP switch. The design fully supports connections with additional EKI-1751I or Advantech Long Reach PoE extenders , specifically for security applications to power IP cameras, VoIP phones and other PoE-compatible devices. The EKI-1751I extenders provide PoE+ compatibility with up to 30W per port. Advantech EKI-1751I Ethernet extenders are the superior choice for quick deployment and efficient installation, all the while reducing cost and strengthening the reliability of industrial networking connections.

1.2 Features

- Transmission of Ethernet data over UTP wire or coaxial cable
- Easy cabling for quick installation
- Long transmission distance up to 1,200 m
- Quick deployment and easy maintenance
- 3-port 100Base-T Ethernet over VDSL2 for high data rates over long distances
- Built-in M12 connector to strengthen mechanical connections
- 2-port RJ45 Ethernet and an M12 connector for plug-n-play device expansion
- M12 connector protection against environmental disturbances
- Industrial rating for -40°C (-40°F) to 75°C (167°F) operation
- Rugged IP30 aluminum enclosure for easy deployment and efficient installation in harsh environments

1.3 Specifications

| Specifications | Description |
|-----------------------|---------------------------------------------------------------------------------------------------------------------------------------------------------------------------------------------------------------------------------------------------------------------------------------------------------------------------------------------------------------------------------------------------------------------------------------------------|
| Hardware Interface | <ul style="list-style-type: none"> ■ 1 x 6-pin terminal block for copper ports ■ 1 x BNC female for coaxial ports ■ 2 x 10/100Base-T-Tx port with RJ45 connectors ■ 1 x 10/100Base-T-Tx port with M12 connectors (4-pin, D-code) |
| 3 Position Dip Switch | <ul style="list-style-type: none"> ■ Selectable target band plan (Asymmetric or Symmetric) ■ Selectable target SNR margin (6dB or 9dB) ■ Selectable OT or RT |
| LED Indicators | <ul style="list-style-type: none"> ■ Power 1, 2 ■ Per 10/100TX port: link/activity, full-duplex ■ Line Speed (Mbps): link/20/40/60/80/100 |
| Power Supply | <ul style="list-style-type: none"> ■ Terminal blocks for redundant DC power inputs ■ Input voltage: 12 to 48 VDC (10 to 60 VDC Max) ■ Power Consumption: 5 Watts maximum ■ Over current protection ■ Reverse polarity protection |
| Standards Support | <ul style="list-style-type: none"> ■ VDSL2 ITU-T G.993.2 ■ VDSL2 Profiles: 17a and 30a |
| Protocol Support | Transparent bridging to higher layer protocols |
| Operating Environment | <ul style="list-style-type: none"> ■ Operating temperature: -40°C (-40°F) to 75°C (167°F) ■ Storage temperature: -40°C (-40°F) to 85°C (185°F) ■ Humidity: 5% - 95% (non-condensing) |
| Physical | <ul style="list-style-type: none"> ■ Hardened aluminum case, IP30 ■ Dimensions (W x D x H): 62 x 135 x 106.5 mm (2.44 x 5.31 x 4.19 inch) ■ Installation: DIN-rail and wall-mount kits |
| Regulatory Compliance | <ul style="list-style-type: none"> ■ Safety: UL60950-1, EN60950-1, IEC60950-1 ■ EMI: CE, FCC Part 15B Class A, EN 61000-6-4 ■ EMS: EN61000-6-2, EN61000-4-2 (ESD), EN61000-4-3 (RS), EN61000-4-4 (EFT), EN61000-4-5 (Surge), EN61000-4-6 (CS), EN61000-4-8 ■ Shock: IEC 60068-2-27 ■ Freefall: IEC 60068-2-32 ■ Vibration: IEC 60068-2-6 |
| Performance | <ul style="list-style-type: none"> ■ 300m (984 ft.): 100Mbps ■ 400m (1,312.34 ft.): 90Mbps ■ 600m (1,968.5 ft.): 65Mbps ■ 800m (2,624.67 ft.): 45Mbps ■ 1,000m (3,280.84 ft.): 35Mbps ■ 1,200m (3,937 ft.): 20Mbps <p>*The above performance data is for reference only. Actual data may vary depending on the quality of the coaxial cable and additional environmental factors.</p> |

1.4 Applications

The solution works in pairs for point to point connectivity. One unit must be configured, using the dip switch, as a master (OT) while the other functions as a remote (RT).



Figure 1.1 Applications

1.5 Reference Performance Data

1.5.1 24AWG Copper Wire

| SNR | 6dB | 6dB | 6dB | 6dB |
|---------------------------|---------------------------|-----------------------------|---------------------------|-----------------------------|
| Profile | Asymmetrical | | Symmetrical | |
| Distance | Upstream Line Rate (Mbps) | Downstream Line Rate (Mbps) | Upstream Line Rate (Mbps) | Downstream Line Rate (Mbps) |
| 300 m (984 ft.) | 65 | 100 | 100 | 100 |
| 400 m (1,312.34 ft.) | 45 | 95 | 70 | 70 |
| 600 m (1,968.5 ft.) | 30 | 65 | 45 | 45 |
| 800 m (2,624.67 ft.) | 10 | 45 | 27 | 27 |
| 1,000 m (3,280.84 ft.) | 6 | 35 | 18 | 18 |
| 1,200 m (3,937 ft.) | 1 | 20 | 8 | 16 |

1.5.2 Coaxial Cable (RG-58/5C-2V)

| SNR | 6dB | | 6dB | |
|---------------------------|---------------------------|-----------------------------|---------------------------|-----------------------------|
| | Asymmetrical | | Symmetrical | |
| Profile | | | | |
| Distance | Upstream Line Rate (Mbps) | Downstream Line Rate (Mbps) | Upstream Line Rate (Mbps) | Downstream Line Rate (Mbps) |
| 400 m (1,312.34 ft.) | 100 | 100 | 100 | 100 |
| 600 m (1,968.5 ft.) | 50 | 100 | 50 | 80 |
| 800 m (2,624.67 ft.) | 50 | 100 | 50 | 80 |
| 1,000 m (3,280.84 ft.) | 45 | 90 | 50 | 60 |
| 1,200 m (3,937 ft) | 40 | 70 | 50 | 50 |
| 1,400 m (4,593.17 ft) | 35 | 55 | 40 | 35 |
| 1,600 m (5,249.344 ft) | 30 | 40 | 35 | 30 |
| 1,800 m (5,905.51ft) | 10 | 35 | 20 | 20 |
| 2,000 m (6,561.68 ft) | 5 | 30 | 15 | 15 |

*The above performance data is for reference only. Actual data rates may vary depending on the quality of the copper wire and additional environmental factors.

Chapter 2

Hardware Description

EKI-1751I is a Long Reach Ethernet extender. This chapter provides an overview and introduces the hardware.

2.1 Product Overview

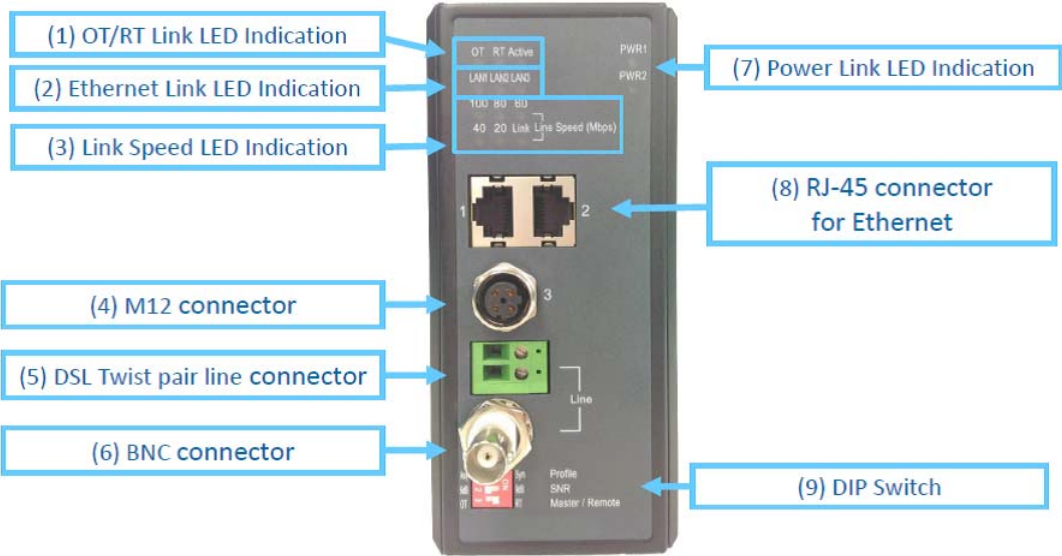

Figure 2.1 Product Overview

2.1.1 Ping assignment for M12 Connector

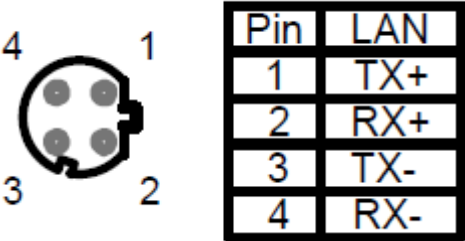

Figure 2.2 Ping assignment for M12 Connector

2.2 Installing Accessory Kits

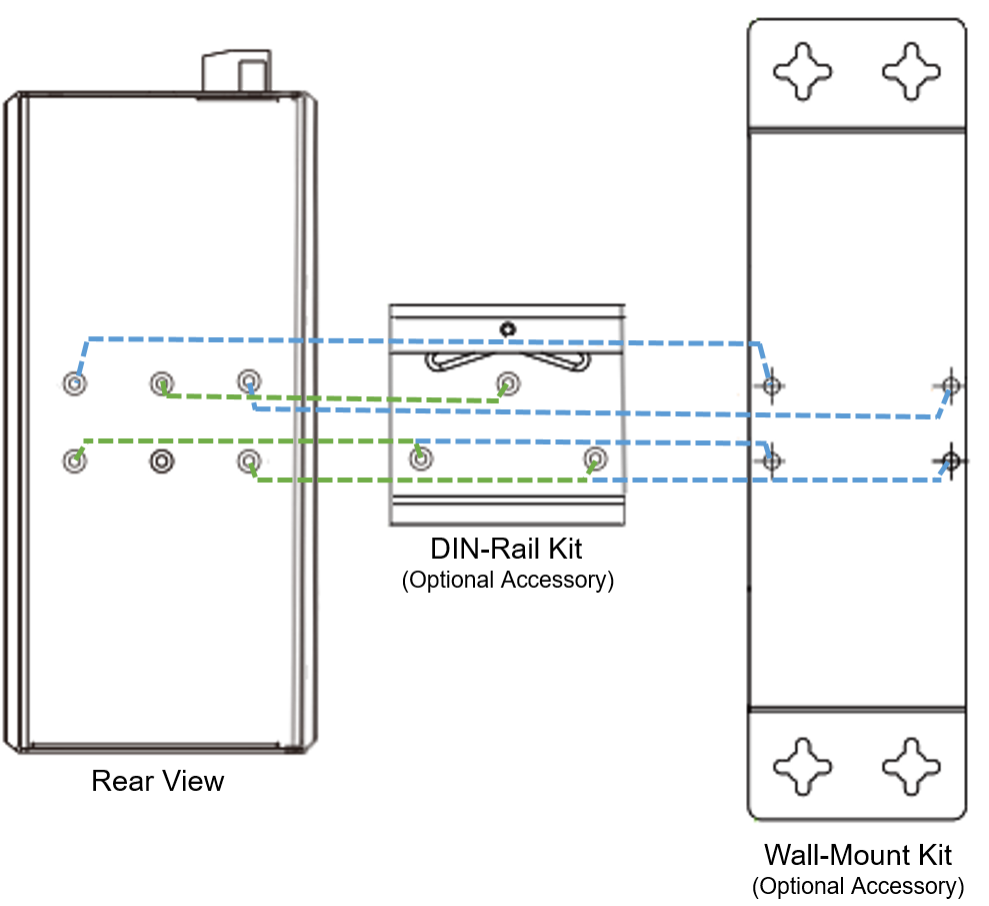

Figure 2.3 Installing Accessory Kits

Chapter 3

LED Definitions

3.1 LED Indicators

The LED indicators could provide instant feedback to users; the behaviors of the LED are given in below table:

| Location | LED Indicative | Status | Description | |
|-----------------------------------------|----------------|--------------------------|-----------------------------------------------------------------|-------------------------------------------------------------------------------------------------------------------------------------------|
| System LEDs | OT (Green) | Off | System in RT mode | |
| | | Solid green | System in OT mode | |
| | RT (Green) | Off | System in OT mode | |
| | | Solid green | System in RT mode | |
| | Active (Green) | Fast blinking green | System fault detected | |
| | | Slow blinking green | System operating normally | |
| | PWR1 (Green) | Off | Power off or not installed | |
| | | Solid green | Power 1 input connected | |
| | PWR2 (Green) | Off | Power off or not installed | |
| | | Solid green | Power 2 input connected | |
| LED per FE port (10/100Base-T/ TX port) | LAN1 | Off | No connection detected or system off | |
| | LAN2 | Solid green | Secure 10/100Mbps connection | |
| | LAN3 | | Blinking green | Data transmission or reception occurring at speed of 10/100Mbps |
| VDSL port | LNK (Green) | Very slow blinking green | No connection detected | |
| | | Slow blinking green | VDSL port processing handshake protocol | |
| | | Fast blinking green | Data transmission or reception occurring at speed of 10/100Mbps | |
| | | Solid green | VDSL port link up | |
| | Speed (Green) | Off | No OT/RT device detected | |
| | | 20 | Solid green | Displays VDSL link speed in Mbps (100M/80M/60M/40M/20M), if 80M LED is on, VDSL downstream link speed range is between 80Mbps to 100Mbps. |
| | | 40 | | |
| 60 | | | | |
| 80 | | | | |
| 100 | | | | |

Chapter 4

Power

- Input:
 - The device provides two terminal blocks for redundant DC power inputs
 - Power Input Voltage is 12 to 48 VDC (10 to 60 VDC Max)
- Power Consumption:
 - 5 Watts maximum
- Protection:
 - Provide over-current protection and reverse polarity protection

Chapter 5

3-Position DIP Switch

The device is equipped with DIP Switch selection which allows users to select the parameters in order to meet varying applications needs.

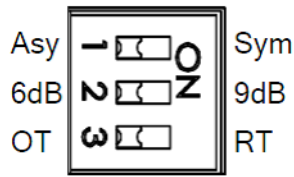

Figure 5.1 3-Position DIP Switch

| Option | Pin 1 | Pin 2 | Pin 3 |
|--------|------------|-------|-----------------|
| | Profile | SNR | Master / Remote |
| OFF | Symmetric | 9dB | OT |
| ON | Asymmetric | 6dB | RT |

5.1 Band Plan

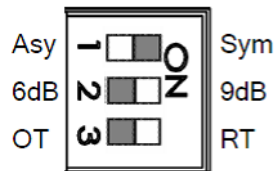

Figure 5.2 PIN 1

- Symmetric: Support the band plan G.997 and provide the symmetric transmission on both downstream and upstream.
- Asymmetric: Provides highest line rate in short range in asymmetric mode.

5.2 General Protection

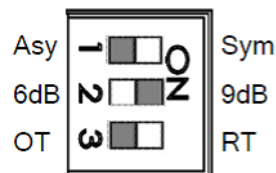

Figure 5.3 PIN 2

- 9 dB: Better channel noise protection with SNR up to 9 dB.
- 6 dB: Original channel noise protection with 6 dB SNR.

5.3 OT (Master) / RT (Remote)

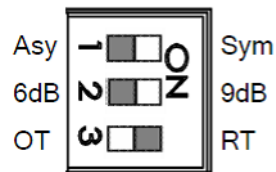

Figure 5.4 PIN 3

- OT: LAN Extender acts as Central Office (CO) side.
- RT: LAN Extender acts as Customer Premise Equipment (CPE) Side.

1. Installation/Operation [Precautions]

Warning! *Disconnect all power from devices before attempting installation.*



Caution! Restricted Access Location



This device is intended for installation only in restricted access locations as defined where both these conditions apply:

- *Access is through the use of a lock or tool and key, or other means of security, and is controlled by the authority responsible for the location.*
- *Access can only be gained by service persons or by users who have been instructed about the reasons for the restrictions applied to the location and about any precautions that shall be taken.*

ADVANTECH

Enabling an Intelligent Planet

www.advantech.com

Please verify specifications before quoting. This guide is intended for reference purposes only.

All product specifications are subject to change without notice.

No part of this publication may be reproduced in any form or by any means, electronic, photocopying, recording or otherwise, without prior written permission of the publisher.

All brand and product names are trademarks or registered trademarks of their respective companies.

© Advantech Co., Ltd. 2018